

The
Gallery Rifle and Pistol
Handbook

of the
National Rifle Association
of the
United Kingdom



Version 4.05, January 2009

Version History

4.01	May 2007	First draft release for Phoenix 2007
4.02	June 2007	Second draft release for Imperial 2007
4.03	January 2008	Third draft for Shooting Committee review
4.04	April 2008	Version approved by Shooting Committee
4.05	January 2009	Updates based on feedback during 2008

Contents

Contents.....	1
Introduction	4
A – Rules.....	5
A1 General.....	5
A1.1 Purpose	5
A2 Firearms and Ammunition	5
A2.1 General	5
A2.2 GRCF – Gallery Rifle Centre Fire.....	5
A2.3 GRSB – Gallery Rifle Small Bore	5
A2.4 LBP – Long Barrelled Pistol.....	6
A2.5 LBR – Long Barrelled Revolver	6
A2.6 Trigger control.....	7
A2.7 Ammunition	7
A3 Conduct of Shooting.....	7
A3.1 Safety.....	7
A3.2 Clothing and Equipment.....	8
A3.3 Range Procedures	9
A3.4 Malfunctions and Reshoots	9
A3.5 Penalties	11
B – General Conditions	12
B1 General.....	12
B1.1 Purpose	12
B2 Officials.....	12
B2.1 Duty to competitors	12
B2.2 Meeting Director.....	12
B2.3 Chief Range Officer (CRO).....	12
B2.4 Range Officer (RO)	12
B2.5 Chief Statistical Officer (Chief Stats)	13
B3 Competitors' Duties.....	13
B3.1 Discipline.....	13
B3.2 Knowledge of meeting conditions.....	13
B3.3 Competitors will score	13
B3.4 Reporting at firing point	13
B3.5 Timing	14
B3.6 Delaying an event	14
B3.7 Loading	14
B3.8 Leaving the firing point	14
B4 Teams.....	14
B4.1 Team representation	14
B4.2 Coaching in team events.....	14
B5 Range Commands	14
B5.1 Firing line commands	14
B5.2 Repeating commands	15
B6 Positions	15
B6.1 Ready position	15
B6.2 Moving between positions	15
B6.3 Prone	15
B6.4 Sitting.....	16
B6.5 Kneeling.....	16
B6.6 Standing unsupported	16
B6.7 Standing using barricade for support.....	16
B7 Firearm and Ammunition Malfunctions	16

B8	SCORING	16
B8.1	When to score	16
B8.2	Who can score	17
B8.3	Where to score.....	17
B8.4	How to score	17
B8.5	Gauging	17
B8.6	Early / late shots.....	17
B8.7	Too many / too few shots	18
B8.8	Scorer's duties	18
B8.9	Competitor's duties.....	18
B8.10	Scorecards.....	19
B9	Ties.....	19
B9.1	Individual events	19
B9.2	Team events	19
B10	Challenges and Protests	19
B10.1	Challenges	19
B10.2	Jury	20
B10.3	Protests.....	20
B10.4	Challenges and protests in team events.....	20
B11	Results.....	20
B11.2	Correction of result errors.....	20
B11.3	Changing final results.....	20
B11.4	Retention of records	21
B12	Classifications.....	21
B12.1	Classifications	21
B12.2	Classified event.....	21
B12.3	Competing in a higher class	21
B12.4	Appeals.....	22
B12.5	Team classification.....	22
B13	Record Scores	22
B13.1	Types of record	22
B13.2	Qualifying scores.....	22
B14	Discipline	22
B14.1	Aliases	22
B14.2	Score and classification falsification	23
B14.3	Cross fires and excess hits.....	23
B14.4	Bribery.....	23
B14.5	Disorderly conduct.....	23
B14.6	Wilful destruction of range equipment.....	23
B14.7	Chronographing	23
B14.8	Refusal to obey	23
B14.9	Evasion of rules.....	23
B14.10	Self-Discipline	23
B14.11	Safety violations	24
B14.12	Loud or abusive language	24
B14.13	Sanctions	24
B14.14	Disqualification	24
B14.15	Expulsion	24
B15	Range Standards.....	25
B15.1	Firing line	25
B15.2	Firing point	25
B15.3	Shelter.....	25
B15.4	Illumination.....	25
B15.5	Target numbers.....	25
B15.6	Event specific range equipment.....	25

C – Event Conditions.....	26
C1 General.....	26
C1.1 Purpose.....	26
C1.2 Event Numbering.....	26
C1.3 Targets.....	27
01 – 25m Precision.....	29
03 – 50m Precision.....	30
05 – America Match.....	31
07 – Timed & Precision 1.....	33
09 – Timed & Precision 2.....	35
10 – Timed & Precision 3.....	38
11 – Multi-Target.....	41
13 – Phoenix A.....	43
15 – 1500.....	46
17 – Bianchi.....	50
19 – Advancing Target.....	54
21 – Speed Steel Challenge.....	56
23 – 25m Timed.....	58
25 – Sport Pistol.....	60
27 – Standard Pistol.....	62
29 – The Grand.....	64
38 – Man v Man.....	66
39 – Metallic Silhouettes.....	68
43 – Granet.....	69
45 – Scott.....	71
47 – Imperial Silhouettes.....	73

Introduction

The governing body for Gallery Rifle (GR) shooting in the UK is the National Rifle Association (NRA). The NRA is also the governing body for Long Barrelled Revolver (LBR) and Long Barrelled Pistol (LBP) shooting (as defined in this Handbook). The discipline under which these three types of firearm are encompassed is defined by the NRA as “Gallery Rifle and Pistol (GR&P)”.

This Handbook, produced under the auspices of the NRA, contains three Sections:

- A. **Rules.** These Rules, which also appear in the NRA Rules of Shooting (sometimes referred to as “The Bible”), **always** apply to GR&P shooting conducted under NRA auspices.
- B. **General Conditions.** This section describes the conditions which apply to all GR&P shooting unless any of these conditions are over-ridden by range-specific, meeting-specific or event-specific conditions.
- C. **Event Conditions.** The GR&P event numbering scheme is explained in this section, which also describes the courses of fire for all GR&P events shot at national level within the UK.

The Handbook will be reviewed and re-released annually in order to address any issues which have arisen during the year. However, if a particularly significant issue is identified then the Handbook may be updated at any time. The most up-to-date version of the Handbook will always be available (in PDF format) for download from the NRA website.

All GR&P meeting organisers, range crew, and competitors should be familiar with the contents of this Handbook.

Copies of the Handbook should be readily available to competitors and support staff at all GR&P meetings.

Any paragraph within this Handbook which also appears in the NRA Bible includes a cross-reference to the relevant Bible paragraph number in square brackets at the end: [xxx].

Any questions or comments on the Handbook should be directed to the NRA’s GR&P Discipline Representative, Charles Murton, by e-mail (gallery@nra.org.uk) or by post through the NRA offices (Bisley, Brookwood, Surrey, GU24 0PB).

A – Rules

A1 General

A1.1 Purpose

A1.1.1 The Rules defined in this Section apply to all use of Gallery Rifles and Pistols under NRA auspices and will be strictly enforced at all GR&P meetings. Any breach will be dealt with under the disciplinary arrangements specified in this Handbook – though these may be superseded by the conditions of the meeting in which the breach occurs. Any competitor witnessing a breach of these rules is required to bring the matter to the attention of a meeting official immediately.

A2 Firearms and Ammunition

A2.1 General

A2.1.1 Firearms that conform to the definitions and dimensions set out in Section 1, Firearms Act 1968 (as amended) are generally eligible subject to special conditions set out below. They fall into the four categories described and will compete in separate events.

A2.1.2 The term “pistol calibre” refers to cartridge firearms and not to muzzle-loaded or front-loaded firearms. Permitted cartridges are those which were originally designed for use in pistols and are restricted to calibres in which Gallery Rifles and/or Pistols are commercially available. [180]

A2.2 GRCF – Gallery Rifle Centre Fire

A2.2.1 Any Gallery Rifle in a centrefire pistol calibre (see above) which is, in the opinion of the NRA, of conventional design and safe, may be used. The standard for GRCF is a lever-action rifle with an integral tube magazine. Gallery Rifles of different designs (e.g. with detachable box magazines or revolvers with shoulder stocks) are permitted in most events. [165]

A2.2.2 All GRCF must comply with the following: [165]

- a. **Calibre.** Any centrefire pistol calibre as defined above. The muzzle velocity must not exceed 2150 ft/sec and the muzzle energy must not exceed 1496 ft. lbs. The use of supplemental chamber inserts in full-bore rifles is permitted (e.g. .45 Colt in a .577/.450, 32 ACP in .303 etc.). “Downloaded” full-bore rifle ammunition is not permitted.
- b. **Trigger Weight.** No minimum permitted trigger weight, but the trigger must be safe in the judgement of the Chief Range Officer (CRO).
- c. **Slings.** The use of slings is prohibited.
- d. **Sights.** Two types of sights are permitted:
 - i. **Iron.** Iron sights which may include sights of any colour.
 - ii. **Optical.** Optical sights may include telescopes and ‘red dot’ sights but not lasers which project onto the target itself.

A2.3 GRSB – Gallery Rifle Small Bore

A2.3.1 Any Gallery Rifle in .22” rimfire which is, in the opinion of the NRA, of conventional design and safe, may be used. The standard for GRSB is a self-loading rifle with a

detachable magazine. Other designs are permitted. All GRSB must comply with the following: [166]

- a. **Calibre.** .22" rimfire only.
- b. **Trigger Weight.** No minimum permitted trigger weight, but the trigger must be safe in the judgement of the CRO.
- c. **Slings.** The use of slings is prohibited.
- d. **Sights.** Two types of sights are permitted:
 - i. **Iron.** Iron sights which may include sights of any colour.
 - ii. **Optical.** Optical sights may include telescopes and 'red dot' sights but not lasers which project onto the target itself.

A2.3.2 Some events permit the use of "Lightweight Sport Rifles". The definition for these guns is based on the NSRA¹ definition for LSRs which is similar to that for GRSB but also encompasses air and CO₂ rifles: [167]

- a. **Calibre.** .22" rimfire (smallbore) or up to 5.6mm (.22") air or CO₂.
- b. **Weight.** Maximum overall weight is 4.5kg (approx 9.925 lbs).
- c. **Magazine Capacity.** Unlimited, but no more than ten rounds may be loaded at one time.
- d. **Trigger Weight.** Minimum permitted trigger weight is 0.5 kg (1.1 lbs).
- e. **Slings.** No items of specialist shooting kit, including slings, are allowed.

A2.3.3 All events open to LSRs are also open to GRSBs. However, events listed as open to GRSBs are not open to air or CO₂ LSRs. [167]

A2.4 LBP – Long Barrelled Pistol

A2.4.1 This category covers all .22" rimfire Long Barrelled Pistols. It includes revolvers and self-loading guns. It also includes single-shot pistols, though these are only likely to be practical in the precision events (numbers 01 and 03 – see Section C). All LBPs must comply with the following criteria: [176]

- a. **Calibre.** .22" rimfire only.
- b. **Trigger Weight.** No minimum permitted trigger weight, but the trigger but must be safe in the judgement of the CRO.
- c. **Sights.** Two types of sights are permitted:
 - i. **Iron.** Iron sights which may include sights of any colour.
 - ii. **Optical.** Optical sights may include telescopes and 'red dot' sights but not lasers which project onto the target itself.

A2.4.2 LBPs capable of being fitted with a shoulder stock may be used provided that the shoulder stock is not attached. A wrist brace or extension rod, if fitted, may only make contact with the body on the hand, or the arm up to the elbow. [177]

A2.5 LBR – Long Barrelled Revolver

A2.5.1 Any Long Barrelled Revolver in a centrefire pistol calibre may be used in this category. All LBRs must comply with the following criteria: [178]

¹ National Small-Bore Rifle Association

- a. **Calibre.** Any pistol calibre.
- b. **Trigger Weight.** No minimum permitted trigger weight but must be safe in the judgement of the CRO.
- c. **Sights.** Two types of sights are permitted:
 - i. **Iron.** Iron sights which may include sights of any colour.
 - ii. **Optical.** Optical sights may include telescopes and 'red dot' sights but not lasers which project onto the target itself.

A2.5.2 LBRs capable of being fitted with a shoulder stock may be used provided that the shoulder stock is not attached. A wrist brace or extension rod, if fitted, may only make contact with the body on the hand, or the arm up to the elbow. [179]

A2.6 Trigger control

A2.6.1 **Double-action.** Double-action firing is accomplished by pulling the trigger of a revolver through with one motion to raise the hammer and let it fall without otherwise cocking the gun. When double-action is specified in the event conditions it must be used.

A2.6.2 **Single-action.** Single-action firing is accomplished by cocking the hammer of a revolver before each shot is fired. The gun may be cocked with either hand. Single-action may be used when it is specified in the event conditions or when no particular action is specified. Double-action can be used instead of single-action at the shooter's discretion.

A2.7 Ammunition

A2.7.1 Either hand loaded or factory loaded ammunition may be used. All ammunition must have sufficient energy to pass through paper/card targets and their backing boards. Shots which do not pass through such targets will be scored as misses. [433]

A2.7.2 All ammunition must be within the limits set out in the range safety certificate for the venue of a competition. Any RO may require a competitor's ammunition to be tested to ensure compliance. Limits on muzzle velocity and muzzle energy for both centrefire and smallbore ammunition will be enforced by testing with a chronograph (see B14.7). [434]

A3 Conduct of Shooting

A3.1 Safety

A3.1.1 All competitors and other personnel in the immediate vicinity of the firing point are required to wear ear protection (e.g. earplugs). Eye protection (e.g. shatterproof glasses) must also be worn when hard targets (e.g. steel plates) are in use. The wearing of eye protection is *very strongly advised* at all times (and may be made mandatory by the conditions of some meetings). [425]

A3.1.2 All firearms must remain boxed or cased until permission to remove them from their box or case has been given by the CRO. [426]

A3.1.3 No competitor may touch an unboxed or uncased firearm except under the supervision of an RO. [426]

A3.1.4 No competitor may load a firearm until ordered to do so by an RO on the firing point. Magazines and speedloaders may be pre-charged but must not be inserted in the firearm until the order to do so has been given. [427]

A3.1.5 While static on the range the muzzles of all firearms must at all times be pointed downrange in a safe direction. [428]

A3.1.6 When moving around the range during an event, firearms must be carried as follows: [429]

- a. **Revolvers.** Either boxed, or holstered, or muzzle up with the cylinder held open by the fingers of the carrying hand.
- b. **Pistols.** Either boxed, or holstered, or muzzle up with the action locked open.
- c. **Rifles.** Vertical with the action open and the muzzle held upwards.

A3.1.7 When not on the firing point all firearms must be in the following condition: [430]

- a. **Revolvers.** Boxed with no rounds in the cylinder and the hammer forward.
- b. **Pistols.** Boxed with the magazine removed, no rounds in the chamber and the hammer forward.
- c. **Rifles.** Cased with any detachable magazine removed, no rounds in the chamber or in any fixed or tubular magazine and with the hammer or striker forward.

A3.1.8 No firearm is to be boxed or cased until it has been proved clear by an RO. [431]

A3.1.9 Where specified in the conditions of a particular event, a belt-mounted holster must be used with an LBP or LBR. Such holsters may be right- or left-handed. Shoulder or cross-draw holsters are not allowed, nor are holsters from which the LBP/LBR is released by inserting a finger within the trigger guard.

A3.1.10 If any RO or any other person on the range considers that there is a potential or actual breach of safety which urgently requires all competitors to stop firing he will immediately give the order "**Stop, Stop, Stop**". All competitors must immediately stop firing, take their finger off the trigger, keep their firearms pointing at the target and await further instructions. No-one may unload or move off the firing point. [432]

A3.2 Clothing and Equipment

A3.2.1 Clothing should be 'normal street type' suitable for the weather conditions during the competition. No clothing may be worn which will, in any manner, give the wearer artificial support. Such clothing includes shooting jackets, coats or vests which have straps or other devices which may be used to stiffen the body, or tightening devices which may be used to stiffen or lend support to the arm. [435]

A3.2.2 A physically handicapped competitor may use artificial support if individually authorised to do so by the Meeting Director. [436]

A3.2.3 All devices or equipment which may facilitate shooting, but which are not mentioned specifically in these rules, or which are contrary to the spirit of these rules, are forbidden. The Meeting Director shall have the right to examine any competitor's equipment. [437]

A3.2.4 It is the responsibility of the competitor to submit any equipment, not specifically authorised, for official inspection and approval in sufficient time prior to the beginning of an event not to cause inconvenience to the competitor or any official. [437]

A3.3 Range Procedures

A3.3.1 During a course of fire a round or magazine may be retrieved from the ground if dropped, or taken from the competitor's equipment if on the ground, only if he has unloaded his firearm, locked it open and it is kept pointing at the target while retrieving the round or magazine. He may not leave the firing point for this purpose. [440]

A3.3.2 No other person may pass rounds or magazines to a competitor unless he has been previously authorised to do so by the CRO, and then only in circumstances where the competitor may need assistance. [441]

A3.3.3 There is no limit on the number of rounds which may be in a firearm at any time provided that no more than the number of rounds prescribed for the event are loaded at a time, and provided also that no more than the required number of shots is fired for that stage. [442]

A3.3.4 Practice is distinct from Zeroing and is defined as shooting an event or part of an event under conditions similar to those which apply to that event. This would include, for example, shooting a timed series of shots or shooting consecutive series of shots from different positions. If a competitor practices any part of an event he may not shoot that event competitively until at least an hour after he finishes practicing. The only exception to this prohibition is where all competitors in an event are given identical practice facilities throughout the whole meeting. [443]

A3.3.5 Zeroing is distinct from Practice and is defined as firing shots at a target in order to zero the gun at a particular distance. Where range conditions permit, a static target will be provided for competitors to test their zero. It will be at a distance determined by the Meeting Director. Once a competitor has finished zeroing, at least half an hour must elapse before he shoots any event competitively unless all competitors in the event are able to shoot competitively immediately after zeroing. [444]

A3.3.6 Competitors must take their position at their numbered firing point in such a manner as not to interfere with adjacent competitors. No portion of the competitor's body may rest on or touch the ground forward of the firing point. [445]

A3.3.7 With the exception of competitors actually firing, and such range personnel as are necessary for the conduct of the match, the firing points and line must be kept clear at all times. Competitors are not permitted to interfere with the handling of targets by range personnel. [446]

A3.3.8 A competitor who has a physical disability (temporary or permanent) which prevents the use of a position specified in the event conditions may assume the next most difficult position instead. The CRO and the Meeting Director must be informed before the start of the event. The following substitutions are permitted: [447]

- a. the Sitting position instead of the Prone position;
- b. the Kneeling position instead of the Sitting position;
- c. the Standing position instead of the Kneeling position.

A3.4 Malfunctions and Reshoots

A3.4.1 A disabled gallery rifle or pistol is one which cannot be safely aimed or fired, or has suffered damage such that it cannot be fired or function properly, or has suffered the loss of a sight or visible damage to the sight(s). [448]

A3.4.2 Any claim that a firearm has become disabled must be made immediately. The fact that the sights may have been improperly adjusted does not constitute disablement. [448]

A3.4.3 Once a firearm has been declared disabled by the CRO it shall not be used again for live firing until the defect has been rectified and the firearm has been declared safe by the CRO. No competitor will be allowed a reshoot due to a disabled firearm. [448]

A3.4.4 No competitor may change a firearm, or interchange parts of a firearm, during an event unless the firearm has become disabled (see A3.4.1). All shots fired up to the time that the disablement is confirmed will stand as part of the official score. Any replacement firearm used to continue an event must be of the same type (GRCF, GRSB, LBP or LBR) as the original. [449]

A3.4.5 Continuation of an event with a repaired or replacement firearm will be at a time determined by the CRO. [449]

A3.4.6 When the firing of a string or series has been interrupted by some occurrence which renders it impossible for one or more competitors to complete the string or series under the conditions of the event, the CRO will proceed as follows: [451]

- a. without being permitted to examine their targets, competitors in the detail who have been prevented from completing their string or series will be asked if they want to reshoot, or if they wish to accept their score as already fired;
- b. those competitors who have elected to take their scores as already fired will have their targets scored in the normal way;
- c. those competitors who have elected to reshoot will have their targets patched or replaced, and will then reshoot the entire string or series.

A3.4.7 Reasons for the procedure in A3.4.6 being required will not include malfunction of the firearm or ammunition but may include: [452]

- a. failure to allow the full time specified for the string or series;
- b. failure of the targets to operate properly or uniformly for the entire string or series;
- c. failure of the targets to remain in position on the frame;
- d. damage to a target or targets rendering proper aiming or scoring impossible;
- e. cross-firing by another competitor;
- f. the appearance of some object in the line of fire which might constitute a hazard;
- g. an accident on the firing point.

A3.4.8 If, due to faulty target operation or error in timing, one or more competitors are allowed more time to complete their string or series than is provided for in the event conditions, the CRO will immediately order all such targets patched or replaced. These targets will not be scored. A complete new string or series will then be fired by the competitors who had extra time allowed. [453]

A3.4.9 If, in the original string or series, some targets operated properly in accordance with the permitted time limit then all such targets will be scored in the normal manner and competitors who shot on those targets will not be required, nor permitted, to reshoot. [453]

A3.4.10 In the case of some accident involving a competitor on the firing point, such as being hit by lead or powder residue, that competitor may stop firing. The competitor concerned will then have the choice of accepting the score already made in that course of fire, or may reshoot that course. [454]

A3.4.11 Special rules, which supersede those described above, for Malfunctions and Reshoots apply in the Home Countries National Match. Each participating country may have up to two competitors, in addition to the members of the team(s), nominated as reserves. These reserves will shoot in the match at the same time and under the same conditions as the teams. The team captains will nominate these individuals at the same time as the team(s) are declared, identifying which is the GRSB reserve and which is the GRCF reserve. If a team member is ruled to have withdrawn from the match, he will be replaced by the appropriate nominated reserve. His score for the match up to the point of withdrawal will be disregarded and replaced by the score of the reserve. Valid reasons for the withdrawal of a team member from the match are:

- a. If his firearm is disabled (see A.3.4.1) or becomes disabled during the match. The decision that a firearm is disabled may only be taken by the CRO.
- b. If he is unable to complete the match due to illness or injury, whether declared prior to the event or arising during the event.
- c. Any other reason accepted as valid by the Meeting Committee (for example, a call on the competitor of such urgency that his immediate departure from the range is essential). Any member of the Meeting Committee acting as a member of a team must declare an interest and take no part in such a decision.

A3.5 Penalties

A3.5.1 In the event of a breach of these rules, the disciplinary sanctions specified in Section B of this Handbook (see B14.13) apply.

A3.5.2 In any competition, any RO may apply a Procedural Penalty to a GR&P competitor if he deems a procedural error to have been made by that competitor. The competitor may appeal such a decision to the Meeting Director. [455]

A3.5.3 A Procedural Penalty will result in the deduction of one hit of the maximum possible score for the target type. Such a penalty shall not be applied more than once for each match, stage or practice of an event. [456]

A3.5.4 Potential procedural errors will depend on individual event conditions, but will include the following: [457]

- a. firing while placing a foot or part of foot over the firing line;
- b. firing while placing a foot or part of a foot on the wrong side of the line behind a barricade;
- c. firing from positions in the wrong order;
- d. adopting an incorrect position.

A3.5.5 This list is neither exhaustive nor exclusive, and is for example only. [457]

B – General Conditions

B1 General

B1.1 Purpose

B1.1.1 This Section defines the General Conditions which should normally be applied to all GR&P shooting. Unlike the Rules provided in Section A, any of the Conditions in this Section may be over-ridden by range-specific, meeting-specific or event-specific conditions. Where the Conditions in this Section do apply, violation of them will result in the same disciplinary procedures as those applied to violation of the Section A Rules.

B2 Officials

B2.1 Duty to competitors

B2.1.1 It shall be the duty of all meeting officials to conduct themselves properly by being fair and impartial to all in carrying out their various duties. No official shall harass a competitor nor allow such practice by another official, other competitors or spectators. Should a competitor's equipment or demeanour warrant sanction, it should be done in such a manner as will cause the least inconvenience to all concerned. In so doing, the official should state to the competitor the Rule or Condition under which the sanction is being applied.

B2.2 Meeting Director

B2.2.1 The Meeting Director has overall responsibility for the entire meeting. In particular, he is responsible for ensuring the safety and proper discipline of all meeting officials, competitors and spectators. He is also responsible for ensuring the efficient conduct of the meeting.

B2.2.2 Instructions from the Meeting Director for the operation of the meeting must be complied with by all persons on the range. The Meeting Director will use his best judgment at all times, seeking advice when required, and his behaviour and decisions must be characterized by absolute impartiality, firmness, courtesy and constant vigilance.

B2.2.3 In all matters relating to the meeting, a decision by the Meeting Director is final.

B2.3 Chief Range Officer (CRO)

B2.3.1 A CRO will be assigned by the Meeting Director to run one or more specific events on a particular range. The CRO is responsible for safety and discipline on that range, as well as for the range's efficient operation. He will be directly responsible for all ROs working under him and will ensure that they are familiar with all relevant Rules and Conditions, particularly including the relevant Event Conditions. He must be constantly alert, impartial in his handling of competitors and courteous though firm. He will deal with any challenges, protests or disciplinary issues calmly and quietly at the firing line or by taking the competitor to one side. Any disturbance to or involvement of other competitors should be avoided.

B2.4 Range Officer (RO)

B2.4.1 Each RO is an assistant to the CRO for a particular range. An RO (sometimes referred to as a Safety Supervisor) is responsible for the safety and discipline of meeting officials, competitors and spectators in the part of the range to which he has been assigned. He will also supervise the scoring of targets. He is responsible for seeing that the

competitor's equipment and position comply with the conditions for the particular event being fired. It is his duty to be completely familiar with the meeting programme and with all relevant Rules and Conditions. He is to comply to the best of his ability with all instructions issued by the Meeting Director or CRO and will render all possible cooperation to other officials. He must be constantly alert, impartial in his handling of competitors and courteous though firm. Any challenges, protests or disciplinary issues should be raised immediately to the CRO.

B2.5 Chief Statistical Officer (Chief Stats)

B2.5.1 Chief Stats is in charge of all statistical work in connection with the meeting except the actual recording of scores when this is done on the range. He is directly responsible to the Meeting Director. He is assisted by such additional Stats Officers as may be required.

B2.5.2 It is the duty of Chief Stats to:

- a. Maintain a list of competitors showing name, competitor number and classifications.
- b. Prepare official scorecards.
- c. Check addition on scorecards and correct totals.
- d. Tabulate scores in order of merit.
- e. Prepare and post interim, provisional and final results.
- f. Produce a prize list.
- g. Report to Meeting Director for appropriate disciplinary action any irregularities in firing or scoring which may be indicated by squadding records or scorecards.
- h. Make required reports to the National Classification organiser within one week of the end of the event.

B3 Competitors' Duties

B3.1 Discipline

B3.1.1 It is the duty of each competitor to cooperate with officials to enable the conduct of a safe and efficient meeting. Competitors are expected to promptly call the attention of meeting officials to any infraction of Rules or Conditions. Failure of a competitor to cooperate in such matters, or to give testimony when called upon to do so, may result in the competitor being considered as an accessory to the offence.

B3.2 Knowledge of meeting conditions

B3.2.1 It is the competitor's responsibility to be familiar with the Rules and Conditions which apply at the meeting and particularly to the events he has entered.

B3.3 Competitors will score

B3.3.1 Competitors will act as scorers when required to do so by a CRO or RO, except that no competitor is allowed to score his own target.

B3.4 Reporting at firing point

B3.4.1 Competitors should arrive at the range in plenty of time for the start of the event and must proceed to the assigned firing points immediately when their squad is called by the CRO. All relevant equipment for that particular event must be ready and in good working

order. Time will not be allowed for repairs, sight adjustments or search for missing equipment after the squad has been called to the firing line.

B3.5 Timing

B3.5.1 It is the competitor's responsibility to complete each string of shots within the time allowed by the Event Conditions. ROs will not announce the time during the firing.

B3.5.2 Unless otherwise specified in the event conditions, timing devices are permitted provided that they do not produce an audible signal. [439]

B3.6 Delaying an event

B3.6.1 No competitor may delay the start of an event through tardiness in reporting or undue delay in preparing to fire.

B3.7 Loading

B3.7.1 No competitor will load a firearm except at the firing point and after the command to load has been given by the CRO.

B3.8 Leaving the firing point

B3.8.1 It is the competitor's duty to ensure that his firearm has been checked clear by an RO before casing that firearm and leaving the firing point. The competitor should ensure that all of his equipment is removed promptly in readiness for the next detail – this includes the removal of any debris (e.g. spent cases).

B4 Teams

B4.1 Team representation

B4.1.1 No competitor may be a member of more than one team in any given team event.

B4.2 Coaching in team events

B4.2.1 Coaching is permitted in all team events and each competitor may have a coach. No optical devices other than binoculars may be used by the coach. The coach may assist team members by calling shots, checking time, checking scoring, ordering sight changes, etc.; but must control voice and actions so as not to disturb other competitors. The coach will not physically assist in loading, or in making sight corrections, or be positioned to serve as a windbreak.

B5 Range Commands

B5.1 Firing line commands

B5.1.1 When ready to start firing an event, the CRO calls the squad to the firing line. He then announces the event, squad, practice/match, position, number of rounds, time allowance, etc. If there are mixed firearm types on the firing line, any differences in Event Conditions between them will be emphasised.

B5.1.2 In the interests of achieving consistency and to avoid confusion among competitors, after the initial commands for loading and preparation (which are contained in the event conditions in Section C) all events will, as far as possible, have the same sequence of range commands:

- a. After the initial commands for loading and preparation have been given, the CRO asks 'ARE YOU READY?'

b. Any competitor who is not ready or whose target is not in order will immediately raise his arm and call 'NOT READY'. The CRO will immediately state 'NOT READY CALLED' and then investigate and correct the difficulty (or direct an RO to do so).

c. When the difficulty has been corrected, or in the absence of a "NOT READY" call, the CRO calls 'STAND BY' and the targets turn away (if turning targets are in use).

B5.1.3 There is then a delay of approximately 3 seconds (this may vary in some events).

B5.1.4 When the targets start to face the firing line, or when an audible signal is given, firing may commence.

B5.1.5 When the targets turn away, or when an audible signal is given, firing must cease immediately. Even if a competitor is about to let off a carefully aimed shot he must hold his fire. The CRO will give the order "UNLOAD AND SHOW CLEAR", after which the ROs will check to make sure that all firearms are unloaded and holstered or cased. The ROs will then report their part of the range clear to the CRO. When all ROs have reported clear, the CRO will declare the range clear and give permission for ROs and competitors to go forward in order to score and replace targets as necessary.

B5.2 Repeating commands

B5.2.1 An RO may repeat the CRO's commands, especially when those commands cannot be clearly heard by shooters under his supervision.

B6 Positions

B6.1 Ready position

B6.1.1 The ready positions for GRSB and GRCE are:

- a. **45 degrees.** The gun loaded and held in both hands with the butt in shoulder and barrel pointing towards ground at an angle of 45 degrees.
- b. **Parallel.** The gun loaded and held in both hands parallel to the ground, pointing at the target array, at waist height.

B6.1.2 The ready positions for LBP and LBR are:

- a. **45 degrees.** The gun loaded and held pointing towards ground at an angle of 45 degrees.
- b. **Holstered.** The gun loaded and in a holster. The competitor must stand erect with arms hanging at the sides. The competitor's hands may not touch the gun or holster before the signal to start firing.

B6.2 Moving between positions

B6.2.1 The rules for each event are shown in the relevant event conditions.

B6.3 Prone

B6.3.1 The prone position is only used with LBP and LBR, and then only on ranges where it is specifically permitted by range regulations. The body is extended on the ground parallel to the line of sight, head towards the target.

B6.3.2 The "roll-over" prone position may also be used as long as the body is extended on the ground generally parallel to the line of sight and the position does not interfere with another competitor.

B6.3.3 The revolver or pistol butt may not touch the ground, but may be supported by one or both hands which may touch the ground and which are extended towards the target.

B6.4 Sitting

B6.4.1 The buttocks must be on the ground. A hand may be extended to the rear for support and one or both knees may be raised. Elbows may not touch the ground and the back cannot rest on the ground. Arms or hands may be supported on or by the knees. The gun may be held by one or both hands, but may not be supported or steadied by either foot.

B6.5 Kneeling

B6.5.1 *Either* Kneeling on one knee, the other extended toward the target. The buttocks may be on a heel or the side of a foot but cannot touch the ground. One arm may be supported on the forward knee. The gun may be held by one or both hands.

B6.5.2 *Or* Kneeling on both knees, the buttocks clear of the ground, though they may rest on the heels. The gun may be held by one or both hands and one or both arms are to be extended without other support.

B6.6 Standing unsupported

B6.6.1 Standing with gun held by one or both hands. All portions of the shooter's clothing, body and gun must be clear of artificial support.

B6.7 Standing using barricade for support

B6.7.1 Both feet must be behind the foot-fault line (which is either real or imaginary) extending from the firing line past the rear of the exposed or shooting side of the barricade. No part of the gun may touch the barricade. When shooting on the left of the barricade the gun must be held with the left hand and only the left trigger finger may be in the trigger guard. When shooting on the right of the barricade the gun must be held with the right hand and only the right trigger finger may be in the trigger guard. Either the shooting hand or the gun may be supported by the other hand; if the support hand is removed, it must still be possible to fire the gun.

B7 Firearm and Ammunition Malfunctions

B7.1.1 Unless otherwise specified in the event conditions, no reshoots will be allowed for defective firearms or ammunition, or for any other malfunction of the competitor's equipment. A competitor may clear stoppages or malfunctions, and may replace rounds which have misfired or been dropped, provided that all safety requirements have been met. Completing a course of fire in this manner will not be regarded as a reshoot. No additional time will be allowed. A loaded magazine may be used to substitute for dropped rounds or in the case of a misfire or malfunction. [450]

B8 SCORING

B8.1 When to score

B8.1.1 If an event is divided into stages, practices, matches or series then targets should be scored at the end of each stage, practice, match or series.

B8.1.2 After firing the required number of strings or shots, upon command of the CRO, competitors may go forward and examine their targets but may not touch them.

B8.2 Who can score

B8.2.1 Targets may be scored by an RO, a Stats officer or another competitor. No competitor may score his own target.

B8.3 Where to score

B8.3.1 Targets may be scored on the target frames, behind the firing line or in the Statistical Office.

B8.3.2 When targets are scored before removal from the frame, the scorer records the hits and has the score accepted by the competitor, using the challenge process if necessary. Each target is then repaired or replaced by a new target.

B8.4 How to score

B8.4.1 If the edge of a shot hole comes in contact with the scoring ring of a target, the shot is given the higher value (inward gauging).

B8.4.2 A shot hole will be scored as a hit provided that it measures no more than one and one-half (1½) times the diameter of the bullet. Any shot hole which is more than 1½ times the diameter of the bullet will be scored as a miss.

B8.4.3 When a bullet enters a target from the back it will be scored as a miss.

B8.4.4 Hits outside the scoring rings are scored as misses.

B8.4.5 Any bullet which does not pass through the target will be scored as a miss.

B8.4.6 Hits on the wrong target will be scored as misses.

B8.4.7 A hole made by a ricochet bullet will be scored as a miss.

B8.5 Gauging

B8.5.1 A scoring overlay gauge may be used by any scorer to determine the value of close shots. Plug-type gauges may only be used by meeting officials. The plug type scoring gauge, if used, will remain in the shot hole until the shot value is agreed upon by the competitor and the scorer, or until removed after a challenge. If the plug type scoring gauge is removed prior to an agreement of shot value, the shot hole may not be re-plugged and must be taken to a Jury (see B10.2).

B8.6 Early / late shots

B8.6.1 If any shots are fired at the target before the signal to commence firing (early shots) or after the signal to cease firing (late shots), the shots of highest value equal to the number fired in error will be scored as misses (e.g. if a competitor fires 2 early/late shots he will lose the 2 highest scoring shot-holes on his target).

B8.6.2 Where a shot timer is used to give the signal to cease firing, any shot fired and recorded up to and including three-tenths (0.3) of a second after the signal to cease firing will be scored as a hit.

B8.6.3 All shots fired by the competitor after he takes his position at the firing point will be counted in his score, even if accidentally discharged, provided that they are not either early or late shots.

B8.7 Too many / too few shots

B8.7.1 As a general rule only those hits which are visible will be scored. An exception will be made in the case where the groupings of 3 or more shots are so close that it is possible for a shot or shots to have gone through the enlarged hole without leaving a mark and there has been no evidence that a shot or shots have gone anywhere other than through the assigned target. In such a case, the shooter will be given the benefit of the doubt and scored hits for the non-visible shots on the assumption they passed through the enlarged hole. If such assumption should place a non-visible hit in either of 2 scoring rings, it is scored in the higher-valued ring.

B8.7.2 If more than the required number of hits appears on the target, any shot which can be identified by the bullet hole as having been fired by some competitor other than the competitor assigned to that target, or as having been fired in a previous string, will be disregarded. If more than the required number of hits then remains on the target, the score given will be that for the required number of hits with the highest scoring values. If the competitor believes that the result achieved by using the highest scoring hits would result in an inappropriate reclassification, he may elect to have the required number of hits with the lowest scoring values recorded instead.

B8.7.3 If a competitor fires fewer than the prescribed number of shots through his own fault, and there are more hits on the target than the shots fired, he will be scored the number of shots of highest value equal to the number he fired and given a miss for each unfired shot.

B8.8 Scorer's duties

B8.8.1 The scorer will:

- a. Record on the scorecard the number of hits of each value at the end of each practice / match / stage.
- b. If required, calculate and record on the scorecard the total score for each practice / match / stage and for the overall event.
- c. Sign the card.
- d. Have the competitor sign the card.

B8.9 Competitor's duties

B8.9.1 The competitor will:

- a. Review the shots on the target and compare the recorded hits on the scorecard with the target at the end of each practice / match / stage.
- b. Review the scorecard for complete entries and accuracy of the hits recorded, making sure that they are of the correct value and that the required number of hits are listed at the end of the practice / match / stage.
- c. At the end of the overall event:
 - Either* Sign the scorecard if the hits and shot values are properly evaluated and recorded, acknowledging acceptance of the score as it appears on the scorecard.
 - Or* Write "challenged" in place of the signature if a shot(s) value is questionable or if there is another reason to challenge. After the

challenge procedure is completed, ensure the scorecard is signed by the range official, then sign it.

Then Submit the scorecard to the Statistical Office.

B8.10 Scorecards

B8.10.1 Scorecards will be prepared by the Statistical Office and delivered to the competitor who will hand the scorecard over to the scorer at the appropriate time. Standard scorecards for GR&P events will be available for download from the NRA website.

B8.10.2 Erasures on scorecards are not permitted. If correction is necessary, it must be made and initialled by the scorer. To make corrections, the scorer should draw a line through the incorrect figure and place the correct figure alongside.

B9 Ties

B9.1 Individual events

B9.1.1 The tie-break rules for each event are shown in the relevant Event Conditions.

B9.2 Team events

B9.2.1 Ties in team events will be broken in the order shown below:

- a. By considering team score as though it was a single score fired by an individual. The same rules apply as those for an individual.
- b. By highest individual aggregate score.
- c. By second highest individual aggregate score,
- d. ... etc.

B10 Challenges and Protests

B10.1 Challenges

B10.1.1 When a competitor feels that a shot fired by him has been improperly evaluated or scored, he may make a challenge. Such challenge must be made immediately upon announcement of the score. See B8.5 for use of gauges. No challenge will be accepted after the target has been handled by the shooter.

B10.1.2 When targets are scored on the target frames, or at a prescribed location behind the firing line, and scoring of a shot is challenged the CRO will immediately call a Jury (see B10.2) who will score the target. If necessary, to avoid delaying the event, the challenged target will be replaced with a clean target and the event will proceed. The Jury will then score the target as soon as possible and notify the competitor.

B10.1.3 When targets are scored in the Statistical Office, a recheck will be made by the Chief Statistical Officer (provided he has not previously scored or checked the target) and the Jury in that order.

B10.1.4 Competitors may challenge their own posted scores within a period specified for the particular event.

B10.1.5 The Meeting Director may challenge any competitor's score. Such challenge must be made within the challenge period and checked by a Jury.

B10.2 Jury

B10.2.1 A Jury of three persons of good standing shall be appointed, as required, by a CRO or by the Meeting Director. The three will be chosen from those with good knowledge and experience of the Rules and Conditions who are not in any way personally involved in the decision.

B10.3 Protests

B10.3.1 A competitor may formally protest any injustice which he feels has been done him (except the evaluation of a target which may be challenged as outlined above).

B10.3.2 A protest must be initiated immediately upon the occurrence of the protested incident. Failure to comply with the following procedure will automatically void the protest:

- a. State the complaint orally to the CRO. If not satisfied with his decision then,
- b. State the complaint orally to the Meeting Director.

B10.4 Challenges and protests in team events

B10.4.1 Team challenges and protests must be made by the Team Captain. Team members who believe they have reason to challenge or protest will state the facts to their Team Captain, who will make the official challenge or protest if he feels such action to be justified.

B11 Results

B11.1.1 **Interim results.** As and when practical, Chief Stats will produce and post results for competitors who have completed the event. These may be used as the basis for challenges (see B10.1).

B11.1.2 **Provisional results.** As soon as possible after all competitors have completed the event, Chief Stats will produce and post a full set of results. Following the posting of these provisional results, competitors will have a specified period within which they may make challenges. This period will be displayed with the provisional results.

B11.1.3 **Final results.** Final results will be produced and posted by Chief Stats Officer once the provisional result challenge period has expired. These results will be used as the basis for the award of prizes.

B11.2 Correction of result errors

B11.2.1 Chief Stats will correct errors which may come to the attention of the Stats Office prior to the publication of the final results.

B11.3 Changing final results

B11.3.1 The final results shall not be changed except on authority of the Meeting Director. Such changes may arise from:

- a. Typographical errors.
- b. Errors in classification of competitors, the competitor having been advised of such error and of his correct classification.
- c. Disqualification or Expulsion of competitors as provided for by the rules.

B11.4 Retention of records

B11.4.1 Chief Stats will ensure that all completed scorecards are retained for 30 days after the end of the meeting.

B12 Classifications

B12.1 Classifications

B12.1.1 A database of the results of all classified events (1500, Bianchi and Short Events) will be maintained.

B12.1.2 Classifications are earned separately for each gun type (GRSB, GRCF, LBP and LBR) in the classified events. The class in which a competitor is placed depends on the highest score achieved prior to the current event. The classifications are revised as necessary after each classified event.

B12.1.3 No classifications are maintained for the 1500 GRCF unrestricted event (see Section C).

B12.1.4 Composite classes are used for the Short Events (Timed & Precision 1, Timed & Precision 2, Multi-Target, Phoenix A and Advancing Target). These are determined by taking the highest class achieved in the component events. For example, if a competitor's highest achieved GRSB scores would qualify him for class A for Timed & Precision 1 and class B for Multi-Target, his national classification for all GRSB short events would be A.

B12.1.5 There is no unclassified class. If a competitor shoots an event for the first time, his event score will determine his classification for that event.

B12.1.6 The minimum qualifying scores for each class for each event are to be found in the relevant course of fire in Section C.

B12.2 Classified event

B12.2.1 A fully classified event is one which follows all the relevant Rules and Conditions in this Handbook, and hence from which scores are counted for the purposes of updating classifications and records (see B13). Awards are given by class. If the classes are not fully used (e.g. two or more are combined for award purposes) this must be specified in the meeting conditions.

B12.2.2 A partially classified event is one which follows the Rules and Conditions in this Handbook, but does not award prizes based on classification. Scores from such events will be used to update classifications and records.

B12.2.3 An event which varies from the Rules and Conditions in this Handbook in any way will be considered unclassified. Scores from such events will not be used to update classifications or records.

B12.3 Competing in a higher class

B12.3.1 Any competitor may elect, before firing, to compete under a higher classification than that which they possess. Anyone who so elects must fire in the higher class throughout the meeting and not revert to the lower classification for any event in the meeting.

B12.4 Appeals

B12.4.1 Any competitor having reason to believe he is improperly classified may submit an appeal to the Meeting Director.

B12.5 Team classification

B12.5.1 Teams are classified by computing the “team average” based on the classification of each firing member of the team. To compute this “team average” the key in the table for the different classes will be used and the team total divided by number of firing members of the team, rounding to the nearest whole number. The “team average” will establish classification of the team but will not affect in any way the individual classification of team members.

Team Table	
Class	Points
X	5
A	4
B	3
C	2
D	1

B13 Record Scores

B13.1 Types of record

B13.1.1 Two types of record are maintained:

- a. **National Records.** These are maintained only for the classified events. National records can be set at any fully or partially classified meeting.
- b. **Phoenix Records.** These are maintained for all events shot at the annual Phoenix meeting.

B13.2 Qualifying scores

B13.2.1 In order for records to be recognized, reports of the scores must be submitted to the classification organiser by the Chief Statistical Officer of the meeting in which they were fired.

B13.2.2 Record scores may not be established by use of scores fired in special positions or with special equipment.

B13.2.3 Scores fired during re-entry events cannot be used to establish records.

B13.2.4 Scores must be complete scores for an entire event. Practice, match or stage scores, or scores for only part of an event, will not be used for records.

B13.2.5 Scores must be fired in individual events. No score fired in a team event will be considered for an individual record.

B14 Discipline

B14.1 Aliases

B14.1.1 No competitor may fire under an assumed name.

B14.1.2 No competitor may register, enter or shoot in an event in the name of another.

B14.2 Score and classification falsification

B14.2.1 No competitor will falsify his score or classification, nor that of any other competitor, nor be an accessory thereto.

B14.3 Cross fires and excess hits

B14.3.1 No competitor will deliberately fire on the wrong target nor fire more than the required number of shots, including hits on some other competitor's target and misses.

B14.4 Bribery

B14.4.1 No person will offer a bribe of any kind to any of the range crew, statistical personnel or others nor be an accessory thereto.

B14.5 Disorderly conduct

B14.5.1 Disorderly conduct or intoxication is strictly prohibited on the range.

B14.6 Wilful destruction of range equipment

B14.6.1 No shooter shall cause any range equipment to become damaged through a deliberate act.

B14.7 Chronographing

B14.7.1 As noted at A2.7.2, any RO may require any competitor's ammunition to be chronographed. The following procedure will be used to chronograph ammunition. Select three of the competitor's rounds at random. Fire all three rounds and follow these steps:

- a. If one round only exceeds the limit, the test is over; the ammunition passes.
- b. If two rounds exceed the limit, the test is repeated with three new rounds.
- c. If all three rounds exceed the limit, the ammunition has failed.

B14.7.2 If test b above is failed, fire three new rounds and follow these steps:

- a. If one round only exceeds the limit, the test is over; the ammunition passes.
- b. If two rounds exceed the limit, the ammunition has failed.

B14.7.3 If the ammunition fails the chronograph test it may not be used. The competitor is Disqualified from any events already shot using that ammunition.

B14.8 Refusal to obey

B14.8.1 No person will refuse to obey instructions of the Meeting Director or any other official if instructions are given in the proper conduct of the office.

B14.9 Evasion of rules

B14.9.1 No competitor will evade or attempt to evade or be an accessory to the evasion of any Rules or Conditions. Refusal of a competitor or meeting official to give testimony regarding facts known to him concerning violations or attempted violation of the Rules and Conditions will constitute being an accessory to the violation or attempted violation.

B14.10 Self-Discipline

B14.10.1 The safety of competitors, range personnel and spectators requires continuous attention by all to the careful handling of firearms and caution in moving about the range.

Self-discipline is necessary on the part of all. Where such self-discipline is lacking it is the duty of range personnel to enforce discipline and the duty of competitors to assist in such enforcement.

B14.11 Safety violations

B14.11.1 Safety violations include the following:

- a. Pointing a firearm, whether loaded or unloaded, in an unsafe direction. An unsafe direction includes any direction up range (i.e. more than 90 degrees away from the target line) or in the direction of another person.
- b. Discharging an unaimed shot that impacts anywhere other than the back stop behind the target line.
- c. Dropping a loaded firearm.
- d. Handling a firearm, whether loaded or unloaded, while not under the direct instructions of an RO, when the range has not been declared clear and / or there are persons down range.
- e. The consumption of alcohol or drugs on the range or during the meeting while competing.

B14.12 Loud or abusive language

B14.12.1 Loud and/or abusive language that disturbs the operation of the event or the competitors while firing is not permitted. Competitors, scorers and ROs will limit their conversation directly behind the firing line to official business. Verbal abuse by competitors or verbal abuse of competitors by range officials is grounds for Disqualification or replacement of those guilty of such action. Disturbance of shooters by spectators is likewise prohibited.

B14.13 Sanctions

B14.13.1 A CRO will Disqualify (see B14.14) a competitor from an event in which he has committed a safety violation (see B14.11.1). The competitor may appeal such a decision to the Meeting Director.

B14.13.2 The Meeting Director, upon proper presentation of evidence, may apply a Procedural Penalty to, Disqualify, or order the Expulsion (see B14.15) of any competitor for violation of Rules or Conditions, or for other conduct considered discreditable or unsafe. In the event of a disagreement on sanctions between meeting officials, the Meeting Director shall prevail.

B14.14 Disqualification

B14.14.1 Competitors who are Disqualified from an event are required to remove themselves and their equipment from the firing point immediately. Their score for the event will be deleted. No refund of entry fees will be given.

B14.15 Expulsion

B14.15.1 Expelled competitors are disqualified from all events at the meeting. They are required to remove themselves and their equipment from the range complex and not to return for the remainder of the meeting. No refund of entry fees will be given. Details of all Expulsions should be reported to the relevant national governing bodies.

B15 Range Standards

B15.1 Firing line

B15.1.1 The firing line is immediately in front of the firing points. All ranges are measured from this firing line to the face of the targets when targets are hung in their proper firing position in front of the backstop.

B15.2 Firing point

B15.2.1 That part of the range provided for the competitor immediately to the rear of the firing line from which firing takes place. Each firing point is numbered to correspond with the target frames. It is recommended that each firing point has a minimum width of 1.8 metres.

B15.3 Shelter

B15.3.1 The firing points of outdoor ranges may be covered and enclosed on three sides, open toward the targets. There must be ample room for meeting officials to move freely to the rear of the shooters. This does not preclude the construction of ranges within areas surrounded or partially surrounded by safety walls.

B15.4 Illumination

B15.4.1 Ranges may be artificially illuminated.

B15.5 Target numbers

B15.5.1 Where target numbers are used, target frames will be numbered on alternating backgrounds of contrasting colours. The numbers will be large enough to be identified with the naked eye under ordinary light conditions. Numbers must correspond with the firing point numbers. Target numbers will be fixed in position so as to remain visible, from all shooting positions, when the targets are exposed.

B15.5.2 A competitor may add his target number, or another distinguishing mark, to the face of the target outside the scoring area if he so wishes.

B15.6 Event specific range equipment

B15.6.1 Some events require specific items of range equipment – this is specified in the relevant event conditions.

C – Event Conditions

C1 General

C1.1 Purpose

C1.1.1 This section of the Handbook describes the courses of fire for all the GR&P events shot competitively at national level in the UK.

C1.2 Event Numbering

C1.2.1 Events are identified by a four-digit number. The first two digits define the event type and the second two define the gun type, as shown in the tables below.

Event Type	
01	25m Precision
03	50m Precision
05	America Match
07	Timed & Precision 1
09	Timed & Precision 2
10	Timed & Precision 3
11	Multi-Target
13	Phoenix A
15	1500
17	Bianchi
19	Advancing Target
21	Speed Steel Challenge
23	25m Timed
25	Sport Pistol
27	Standard Pistol
29	Grand
31	<i>Hunter Field Target</i>
33	<i>BDMP Embassy Cup</i>
35	<i>TBT</i>
38	Man v Man
39	Metallic Silhouettes
41	<i>Classic</i>
43	Granet
45	Scott
47	Imperial Silhouettes
51	<i>100 yd</i>
53	<i>100 & 200 yd</i>
55	<i>200 & 300 yd</i>
57	<i>100, 200 & 300 yd</i>

Gun Type	
01	GRSB / LSR
02	GRCF
03	<i>Air Rifle (AR)</i>
04	<i>Shotgun (SG)</i>
05	<i>Shotgun – Pump (SGP)</i>
06	<i>Shotgun – Semi-Auto (SGSA)</i>
21	LBP
22	LBR
23	<i>Air Pistol (AP)</i>
<i>Muzzle Loading</i>	
41	<i>Pistol (MLP)</i>
42	<i>Revolver (MLR)</i>
43	<i>Classic Revolver (black powder only)</i>
44	<i>Classic Percussion</i>
45	<i>Classic Flintlock (smoothbore)</i>
46	<i>Classic Flintlock (rifled)</i>
<i>Long Range Pistol</i>	
61	<i>Allcomers A</i>
62	<i>Allcomers B</i>
63	<i>Free Pistol A</i>
64	<i>Free pistol B</i>
65	<i>Production Free Pistol A</i>
66	<i>Production Free Pistol B</i>
67	<i>Revolver A</i>
68	<i>Free Pistol 18.5" barrel</i>
<i>Full-Bore Rifle</i>	
80	<i>Any</i>
81	<i>.303 (pre-1950 iron sights)</i>
82	<i>Military Rifle (pre-1980 iron sights)</i>

59	<i>400, 500 & 600 yd</i>
61	<i>800, 900 & 1000 yd</i>
63	<i>200m</i>
65	<i>McQueen</i>
71	<i>Clays</i>

83	<i>Military Rifle (pre-1980 any sights)</i>
84	<i>.303 (any)</i>
85	<i>Sporting Rifle</i>
86	<i>F Class</i>
87	<i>Black Powder Cartridge</i>
89	<i>Non .303 Military (pre-1950 iron sights)</i>

C1.2.2 Note that, for completeness, the tables include event and gun types which are sometimes used within GR&P meetings (particularly the annual Phoenix meeting) but which do not fall within the governance of the GR&P discipline. These are indicated in italics. Courses of fire for these are not included in this Handbook – they will instead be provided separately for each meeting in which they appear.

C1.3 Targets

C1.3.1 The courses of fire described later in this section utilise a wide variety of target types. These are illustrated below.



PL7

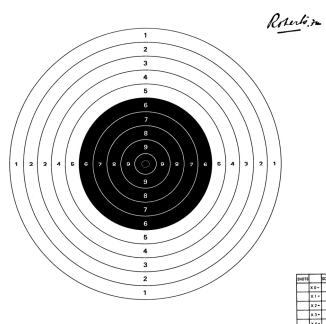

PL14

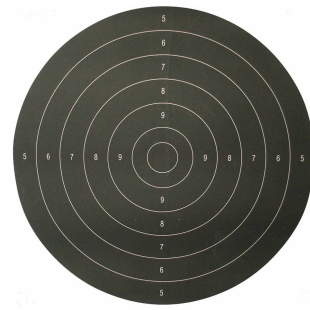

PL17

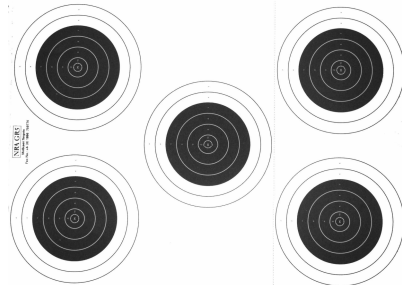

NRA GR5



DP1 / 1a



DP2 / 2a

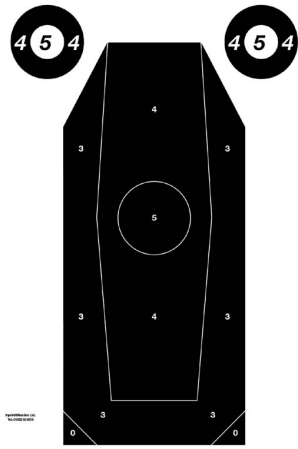

TP3

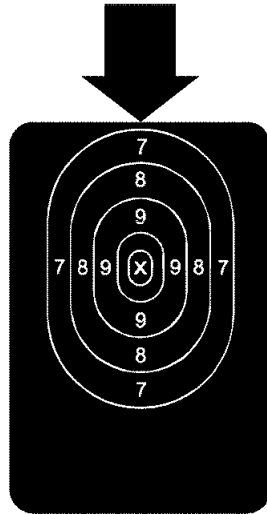

B1

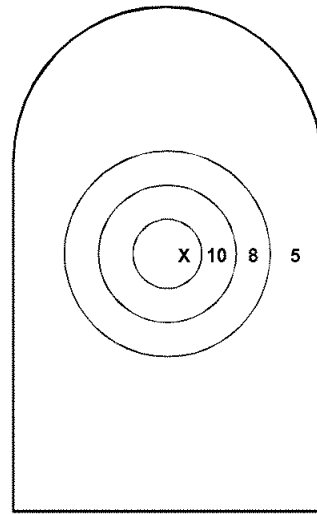

D1

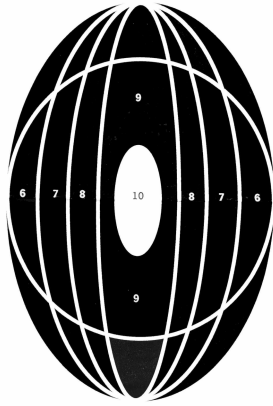

Melon



5 of Diamonds

01 – 25m Precision

Event Numbers

0101: LSR
0102: GRCF
0121: LBP
0122: LBR

Targets

LSR, LBP: 1 x PL14
GRCF, LBR: 1 x PL7

Sights

Any (spotting scopes may be used)

Position

Standing unsupported

Ready Position

45 degrees

Course of Fire

This event is shot at 25 metres
It takes approximately 45 minutes to complete
It requires 30 rounds plus sighters (unlimited)
The maximum possible score is 300

Sighters

Unlimited shots in 5 minutes

Practice 1, 2, 3

10 shots in 5 minutes

Range Commands

The general rules apply with the addition of the following initial command.
Having made sure that the range is clear, the CRO commands 'LOAD AND MAKE READY'.

Ties

Tie breaking rules shall be applied in the order listed below:

- a. By the greatest number of Xs in the event.
- b. By the scores in each practice in the order 3, 2, 1.
- c. By the X count in each practice in the order 3, 2, 1.

03 – 50m Precision

Event Numbers

0301: GRSB

0302: GRCF

0321: LBP

0322: LBR

Targets

1 x PL7

Sights

Any (spotting scopes may be used)

Positions

Standing unsupported

Ready Position

45 degrees

Course of Fire

This event is shot at 50 metres

It takes approximately 45 minutes to complete

It requires 30 rounds plus sighters (unlimited)

The maximum possible score is 300

Sighters

Unlimited shots in 5 minutes

Practice 1, 2, 3

10 shots in 5 minutes

Range Commands

The general rules apply with the addition of the following initial command.

Having made sure that the range is clear, the CRO commands 'LOAD AND MAKE READY'.

Ties

Tie breaking rules shall be applied in the order listed below:

- a. By the greatest number of Xs in the event.
- b. By the scores in each practice in the order 3, 2, 1.
- c. By the X count in each practice in the order 3, 2, 1.

05 – America Match

Event Numbers

0501: GRSB
0502: GRCF
0521: LBP
0522: LBR

Targets

50 metres: 1 x PL7
25 metres: GRSB: 1 x NRA GR5 GRCF, LBP, LBR: 1 x PL7

Sights

Any

Positions

Standing unsupported

Ready Position

45 degrees

Course of Fire

This event takes approximately 45 minutes to complete
It requires 30 rounds plus sighters (unlimited)
The maximum possible score is 300

Sighters

50 metres, unlimited shots in 5 minutes

Practice 1

50 metres, two series of 5 shots in 5 minutes, standing unsupported

Practice 2

25 metres, two series of 5 shots in 30 seconds, standing unsupported

Practice 3

25 metres, two series of 5 shots in 20 seconds, standing unsupported

Range Commands

The general rules apply with the addition of the following initial command.
Having made sure that the range is clear, the CRO commands 'WITH FIVE ROUNDS LOAD AND MAKE READY'.

Ties

Tie breaking rules shall be applied in the order listed below:

- a. By the greatest number of Xs in the event.
- b. By the scores in each practice in the order 1, 3, 2.

- c. By the X count in each practice in the order 1, 3, 2.

07 – Timed & Precision 1

Event Numbers

0701: GRSB
0702: GRCF
0721: LBP
0722: LBR

Targets

GRSB: 1 x DP2a
GRCF, LBP, LBR: 1 x DP2

Sights

Any

Positions

Standing unsupported

Ready Position

45 degrees

Course of Fire

This event takes approximately 30 minutes to complete
It requires 30 rounds
The maximum possible score is 300

Practice 1

25 metres, 12 shots in 2 minutes, to include a reload

Practice 2

15 metres, 12 shots in two strings of 6
For each string, 6 appearances of 2 seconds with intervals of 5 seconds
One shot only to be fired at each appearance
The firearm must be returned to the ready position between appearances

Practice 3

10 metres, 6 shots
The target will make 3 appearances of 3 seconds with intervals of 5 seconds
Two shots only to be fired at each appearance
The firearm must be returned to the ready position between appearances

Range Commands

The general rules apply with the addition of the following initial command.
Having made sure that the range is clear, the CRO commands 'WITH SIX ROUNDS LOAD AND MAKE READY'.

Scoring

Where any competitor achieves the highest possible score, his targets must be removed from the backing boards, labelled and passed to Stats.

Ties

Tie breaking rules shall be applied in the order listed below:

- a. By the greatest number of Xs in the event.
- b. By the scores at each distance, commencing with the longest distance.
- c. By the X count at each distance, commencing with the longest distance.
- d. In the event of a maximum score and equal X counts at all distances, by outward gauging.

Procedural penalties – event specific

In addition to the usual procedural penalties, the following apply in this event:

- a. Firing too many shots during an exposure.

Classifications

The classification score bands are as follows:

GRSB		GRCF		LBP		LBR	
X	295 - 300	X	300	X	295 - 300	X	295 - 300
A	285 - 294	A	297 - 299	A	285 - 294	A	285 - 294
B	up to 284	B	up to 296	B	up to 284	B	up to 284

09 – Timed & Precision 2

Event Numbers

0901: GRSB
0902: GRCF
0921: LBP
0922: LBR

Targets

GRSB: 1 x DP2a
GRCF, LBP, LBR: 1 x DP2

Sights

Any

Positions

Standing unsupported

Ready Position

GRSB, GRCF: 45 degrees
LBP, LBR: holstered

Course of Fire

This event takes approximately 45 minutes to complete
It requires 60 rounds
The maximum possible score is 600

Practice 1

10 metres, 6 shots, standing unsupported
Time: GRCF - 8 seconds GRSB, LBR, LBP - 5 seconds
This practice will be shot twice

Practice 2

50 metres
GRSB, GRCF: 6 shots kneeling
6 shots sitting
6 shots left hand standing unsupported
6 shots right hand standing unsupported
LBP, LBR: 6 shots kneeling or prone (depending on range restrictions)
6 shots sitting
6 shots left hand standing using barricade for support,
revolvers double action only
6 shots right hand standing using barricade for support,
revolvers double action only
Time: GRCF - 180 seconds GRSB, LBR, LBP - 150 seconds

Practice 3

25 metres
GRSB, GRCF: 6 shots kneeling
6 shots sitting

	6 shots right hand standing unsupported
	6 shots left hand standing unsupported
LBP, LBR:	6 shots kneeling
	6 shots sitting
	6 shots right hand standing using barricade for support, revolvers double action only
	6 shots left hand standing using barricade for support, revolvers double action only
Time:	GRCF - 120 seconds GRSB, LBR, LBP - 105 seconds

Range Commands

The general rules apply with the addition of the following initial command.
Having made sure that the range is clear, the CRO commands 'WITH SIX ROUNDS LOAD AND MAKE READY'.

Loading

All ammunition must be carried on the competitor's person.
When shooting with a revolver, only one speedloader may be used.

Equipment

When shooting this event with a LBP or LBR a holster must be used.

Event specific range equipment

A barricade will be provided for each competitor using a LBP or LBR for the standing with support position at both 25 and 50 metres. It should be a wooden post, square or rectangular in section, fixed on the firing line and sufficiently strong to remain immobile. It should, ideally, be at least 100mm square and two metres in height.

Moving between positions

Firearms must be unloaded when moving between positions. All rounds and cases must be ejected before moving. GRSB and self-loading pistols must have the action locked open and the magazine removed. Revolvers must have the cylinder open. GRCF must have the lever or action open. These conditions do not apply when moving the firearm between shoulders / hands in the standing position.

Reloading

After the initial order to load, all further loading must be with rounds taken from the competitor's pocket, cartridge belt, mechanical loader, special pouch or elsewhere on the competitor's person. It is the competitor's responsibility to have sufficient ammunition in his possession to complete the match or event.

Ties

Tie breaking rules shall be applied in the order listed below:

- a. By the greatest number of Xs in the event.
- b. By the scores at each distance, commencing with the longest distance.
- c. By the X count at each distance, commencing with the longest distance.

Procedural penalties – event specific

In addition to the usual procedural penalties, the following apply in this event:

- a. Moving between positions with a closed firearm.
- b. Allowing part of a LBR or LBP to make contact with the barricade when firing.

Classifications

The classification score bands are as follows:

GRSB		GRCF		LBP		LBR	
X	575 - 600	X	590 - 600	X	580 - 600	X	580 - 600
A	525 - 574	A	575 - 589	A	560 - 579	A	560 - 579
B	up to 524	B	up to 574	B	up to 559	B	up to 559

10 – Timed & Precision 3

Event Numbers

1021: LBP
1022: LBR

Targets

1 x TP3

Sights

Any

Positions

Standing unsupported, kneeling, sitting

Ready Position

Holstered

Course of Fire

This event takes approximately 30 minutes to complete.
There is a maximum shooting time of 5 minutes 30 seconds allowed for the whole event. Each competitor will be supervised by a Range Officer with a timer to monitor his total shooting time. The timer is started when the targets appear for each practice and is stopped when the LBP or LBR is holstered at the end of each practice. The competitor may ask how much time remains once only during the whole event. Once the shooting time has elapsed, the competitor will be stopped. It requires 50 rounds.
The maximum possible score is 250.

Practice 1

10 metres
10 shots standing unsupported
Time: 15 seconds

Practice 2

25 metres
5 shots right hand standing using barricade for support, LBR double action only
5 shots left hand standing using barricade for support, LBR double action only
Time: unlimited (subject to the maximum overall time of 5 minutes 30 seconds)

Practice 3

25 metres
5 shots kneeling
5 shots sitting
Time: unlimited (subject to the maximum overall time of 5 minutes 30 seconds)

Practice 4

20 metres
5 shots kneeling
Time: unlimited (subject to the maximum overall time of 5 minutes 30 seconds)

Practice 5

15 metres
5 shots standing unsupported
Time: 10 seconds

Practice 6

10 metres
5 shots standing unsupported, one ring target, strong hand only
5 shots standing unsupported, the other ring target, freestyle
Time: unlimited (subject to the maximum overall time of 5 minutes 30 seconds)

Range Commands

The general rules apply with the addition of the following initial command.
Having made sure that the range is clear, the CRO commands 'WITH FIVE ROUNDS LOAD AND MAKE READY'.

Loading

All ammunition must be carried on the competitor's person in a pocket (i.e. belt loops, pouches, etc. cannot be used).
Any number of magazines, speedloaders or moon-clips may be used but only one may be pre-loaded (with 5 rounds). Competitors are advised to have a minimum of three moon clips or magazines.

Equipment

A holster must be used.

The competitor may not use any form of timing device.

Event specific range equipment

A barricade will be provided for the standing supported position at 25 metres. It should be a wooden post, square or rectangular in section, fixed on the firing line and sufficiently strong to remain immobile. It should, ideally, be at least 100mm square and two metres in height.

Moving between positions

Firearms must be unloaded when moving between shooting positions. All rounds and cases must be ejected before moving. LBP must have the slide back and the magazine removed, LBR must have the cylinder open. These conditions do not apply when moving the firearm between hands in the standing position.

Reloading

After the initial order to load, all further loading must be with rounds taken from the competitor's person. It is the competitor's responsibility to have sufficient ammunition in his possession to complete the match or event. A dropped round, magazine, moon clip or speedloader may not be retrieved.

After each practice is completed, the timer will not be stopped until the competitor has reloaded with five rounds and holstered the gun with the hammer down on an empty chamber. The exceptions are after Practice 1 and Practice 6 – the competitor must not reload, but instead must holster an empty firearm. The RO will clear the firearm after the timer has been stopped.

Scoring

The target will be scored at the end of Practice 1 and at the end of Practice 6 – but not at the end of Practices 2-5.

Ties

Tie breaking rules shall be applied in the order listed below:

- a. By the highest score in Practice 6.
- b. By the scores at each distance, commencing with the longest distance.

Procedural penalties – event specific

In addition to the usual procedural penalties, the following apply in this event:

- a. Moving between shooting positions with a closed firearm.
- b. Allowing part of an LBP or LBR to make contact with the barricade when firing.
- c. In scoring Practices 2-5, hits up to the correct number specified in the course of fire will count. Excess hits will be disregarded. The highest scoring hits up to the correct number only will be scored.

11 – Multi-Target

Event Numbers

1101: GRSB
1102: GRCF
1121: LBP
1122: LBR

Targets

GRSB: 2 x DP1a
GRCF, LBP, LBR: 2 x DP1

Sights

Any

Positions

Standing unsupported

Ready Position

45 degrees

Course of Fire

This event takes approximately 30 minutes to complete
It requires 24 rounds
The maximum possible score is 120

Practice 1

25 metres, 6 shots in 15 seconds on the left hand target

Practice 2

20 metres, 3 shots on each target in 10 seconds

Practice 3

15 metres, 6 shots
The target will make 3 x 3 second appearances with intervals of 5 seconds
2 shots to be fired at each appearance on the right hand target
The firearm must be returned to the ready position between exposures

Practice 4

10 metres, 6 shots (3 on each target) in 8 seconds

Range Commands

The general rules apply with the addition of the following initial command.
Having made sure that the range is clear, the CRO commands 'WITH SIX ROUNDS LOAD AND MAKE READY'.

Scoring

Where any competitor achieves the highest possible score, his targets should be re-scored using outward gauging.

Ties

Tie breaking rules shall be applied in the order listed below:

- a. By the scores at each distance, commencing with the longest distance.
- b. By the greatest number of hits of the highest value.
- c. By the fewest number of hits which score the lowest value, in ascending order.
- d. In the event of the highest possible score being attained, by outward gauging.

Procedural penalties – event specific

In addition to the usual procedural penalties, the following apply in this event:

- a. Firing too many shots during an exposure.
- b. Any shots on the wrong target.

Classifications

The classification score bands are as follows:

GRSB		GRCF		LBP		LBR	
X	110 - 120	X	115 - 120	X	115 - 120	X	115 - 120
A	100 - 109	A	108 - 114	A	105 - 114	A	105 - 114
B	up to 99	B	up to 107	B	up to 104	B	up to 104

13 – Phoenix A

Event Numbers

1301: GRSB
1302: GRCF
1321: LBP
1322: LBR

Targets

GRSB: 2 x DP1a
GRCF, LBP, LBR: 2 x DP1

Sights

Any

Positions

Standing unsupported

Ready Position

GRSB, GRCF: 45 degrees
LBP, LBR: holstered

Course of Fire

This event takes approximately 45 minutes to complete
It requires 40 rounds
The maximum possible score is 200

Practice 1

25 metres, 5 shots kneeling & 5 shots sitting.
Start in the standing position, firearm loaded but not made ready.
The targets will edge for 10 seconds, during which the competitor will adopt a kneeling position, make ready and take aim. The targets will then face for 10 seconds, during which the competitor will fire 5 shots at the left hand target. The targets will then edge for 10 seconds, during which time the competitor must adopt a sitting position, and may then take aim while waiting for the target to face. The targets will reappear for a further 10 second exposure, and the competitor will fire 5 shots at the right hand target.
Note: the competitor is allowed to move from the kneeling to sitting position as soon as he has fired his first 5 shots – there is no need to wait for the targets to edge.

Practice 2

20 metres, 10 shots standing unsupported.
Start in the standing position at 25 metres with the rifle at the 'trail', loaded but not made ready. Revolvers must be loaded and holstered. Pistols must be loaded and holstered with **no** round in the chamber.
The targets will appear for 1 second. The competitor will then have 7 seconds to advance to 20 metres, draw if using a revolver or pistol, and make ready. The targets will then make 5 exposures of 3 seconds with an away time of 7 seconds. Two shots only to be fired at each exposure at the left hand target.
The firearm must be held at 45 degrees between exposures.

Practice 3

15 metres, 10 shots standing unsupported.

Start in the standing position at 20 metres with the rifle at the 'trail', loaded but not made ready. Revolvers must be loaded and holstered. Pistols must be loaded and holstered with **no** round in the chamber.

The targets will appear for 10 seconds, during which the competitor will advance to 15 metres, draw if using a revolver or pistol, make ready and fire one shot at each target. The targets will then make 4 more exposures of 3 seconds with an away time of 7 seconds. Two shots to be fired at each exposure, one shot on each target.

The firearm must be held at 45 degrees between exposures.

Practice 4

10 metres, 10 shots standing unsupported

Start in the standing position at 15 metres with the rifle at the 'trail', loaded but not made ready. Revolvers must be loaded and holstered. Pistols must be loaded and holstered with **no** round in the chamber.

The targets will appear for 10 seconds, during which the competitor will advance to 10 metres, draw if using a revolver or pistol, make ready and fire. There will be two more exposures of 5 seconds. The away time will be 7 seconds. Any number of shots may be fired at each exposure but only 5 shots will be counted on each target.

The firearm must be held at 45 degrees between exposures.

Range Commands

The general rules apply with the addition of the following initial command.

Having made sure that the range is clear, the CRO commands 'LOAD BUT DO NOT MAKE READY'.

Loading

If by design the firearm is not capable of loading 10 rounds the competitor may load the remaining rounds after they have made ready or during the away times.

Equipment

When shooting this event with a LBP or LBR a holster must be used.

Moving between positions

Rifles and pistols must either have no round in the chamber or have the safety applied when moving between positions. Revolvers must have the chamber open. Movement between positions (kneeling to sitting) is only required in Practice 1.

Trail

The rifle held in the strong hand, parallel to the ground and pointing at the target array. The arm must be fully extended downwards.

Scoring

Where any competitor achieves the highest possible score, his targets should be re-scored using outward gauging.

Ties

Tie breaking rules shall be applied in the order listed below:

- a. By the scores at each distance, commencing with the longest distance.
- b. By the greatest number of hits of the highest value.
- c. By the fewest number of hits which score the lowest value, in ascending order.
- d. In the event of the highest possible score being attained, by outward gauging.

Procedural penalties – event specific

In addition to the usual procedural penalties, the following apply in this event:

- a. Firing too many shots during an exposure.
- b. Any shots on the wrong target.
- c. Moving forward with a round in the chamber.
- d. Moving between positions in Practice 1 with a round in the chamber but no safety catch applied.

Classifications

The classification score bands are as follows:

GRSB		GRCF		LBP		LBR	
X	175 - 200	X	185 - 200	X	175 - 200	X	175 - 200
A	160 - 174	A	175 - 184	A	160 - 174	A	160 - 174
B	up to 159	B	up to 174	B	up to 159	B	up to 159

15 – 1500

Event Numbers

1501: GRSB
1502: GRCF
1502u: GRCF unrestricted
1521: LBP
1522: LBR

Targets

GRSB: B1 reduced
GRCF, LBP, LBR: B1 full-size

Sights

Any

Positions

GRSB, GRCF: standing unsupported, kneeling and sitting
LBP, LBR: standing unsupported, standing supported, kneeling and sitting

Ready Position

GRSB, GRCF: parallel
LBP, LBR: holstered

Course of Fire

This event takes approximately 90 minutes to complete
It requires 150 rounds
The maximum possible score is 1500
Different conditions apply to each of the four categories of firearm; these are shown under each match and referenced to each category

Match 1

Stage 1 10 metres 12 shots, including reload, standing unsupported
Stage 2 15 metres 12 shots, including reload, standing unsupported
GRCF – 30 seconds; GRSB, LBP, LBR – 20 seconds
LBR – double action only

Match 2

25 metres, 90 seconds (including reloads)
6 shots kneeling
6 shots left hand GRSB, GRCF standing unsupported
LBP standing using barricade for support
LBR standing using barricade for support
revolvers – double action only
6 shots right hand GRSB, GRCF standing unsupported
LBP standing using barricade for support
LBR standing using barricade for support
revolvers – double action only

Match 3

50 metres, 2 minutes 45 seconds (including reloads)

GRCF, GRSB: 6 shots kneeling
6 shots sitting
6 shots left hand standing unsupported
6 shots right hand standing unsupported

LBP, LBR: 6 shots sitting
6 shots kneeling using barricade for support or prone
(depending on range restrictions)
6 shots left hand standing using barricade for support
6 shots right hand standing using barricade for support
revolvers – single or double action

Match 4

25 metres, 35 seconds (including reload)

Stage 1 12 shots standing unsupported

Stage 2 12 shots standing unsupported

LBR – double action only

Match 5

Stage 1 10 metres 12 shots standing unsupported

GRCF – 30 seconds; GRSB, LBP, LBR – 20 seconds

Stage 2 25 metres, 90 seconds (including reload)

6 shots kneeling

6 shots left hand GRSB, GRCF standing unsupported
LBP standing using barricade for support
LBR standing using barricade for support
revolvers – double action only

6 shots right hand GRSB, GRCF standing unsupported
LBP standing using barricade for support
LBR standing using barricade for support
revolvers – double action only

Stage 3 50 metres, 2 minutes 45 seconds (including reload)

GRCF/GRSB 6 shots kneeling
6 shots sitting
6 shots left hand standing unsupported
6 shots right hand standing unsupported

LBR/LBP 6 shots sitting
6 shots kneeling using barricade for support or prone
(depending on range restrictions)
6 shots left hand standing using barricade for support
6 shots right hand standing using barricade for support
revolvers – single or double action

Stage 4 25 metres, 12 seconds 6 shots standing unsupported
revolvers – double action only

Range Commands

The general rules apply with the addition of the following initial command.

Having made sure that the range is clear, the CRO commands 'WITH SIX ROUNDS LOAD AND MAKE READY'.

Moving between positions

Firearms must be unloaded when moving between positions. All rounds and cases must be ejected before moving. GRSB and self-loading pistols must have the action locked open and the magazine removed. Revolvers must have the cylinder open. GRCF must have the lever or action open. This rule does not apply when moving the firearm between shoulders / hands in the standing position.

Firearm Restrictions – GRCF

In event 1502, only lever-action GRCF with tubular magazines may be used. No speedloading devices are permitted. Note that International matches will usually be shot under these conditions.

In event 1502u, there is no restriction on the type of GRCF or accessories that may be used.

Reloading

After the initial order to load, all further loading must be with rounds taken from the competitor's pocket, cartridge belt, mechanical loader, special pouch or elsewhere on the competitor's person. [Back-to-back magazines are permitted, as are rounds in pouches etc. on the gun.](#) It is the competitor's responsibility to have sufficient ammunition in his possession to complete the match or event.

Ties

Tie breaking rules shall be applied in the order listed below:

- a. By the greatest number of Xs in the event.
- b. By the greatest number of Xs in Matches Three and Four combined.
- c. By the fewest misses in the event.
- d. By the fewest number of shots of lowest value in that event.
- e. By the fewest number of shots of the next lower value in the event.

Event specific range equipment

A barricade will be provided for each competitor using an LBP or LBR for the standing supported position at both 25 and 50 metres. It should be a wooden post, square or rectangular in section, fixed on the firing line and sufficiently strong to remain immobile. It should, ideally, be at least 100mm square and two metres in height.

Procedural penalties – event specific

In addition to the usual procedural penalties, the following apply in this event:

- a. Moving between positions with a closed firearm.
- b. Allowing part of an LBR or LBP to make contact with the barricade when firing.
- c. [For LBP and LBR, when using the barricade, allowing any part of a foot to extend over the foot fault line extending to the rear of the barricade at 90 degrees to the firing line. In the left hand barricade position, no part of the foot may extend to the left of the foot fault line and vice versa.](#)

Classifications

The classification score bands are as follows:

GRSB		GRCF (1502)		LBP		LBR	
X	1475 - 1500	X	1490 - 1500	X	1460 - 1500	X	1460 - 1500
A	1450 - 1474	A	1480 - 1489	A	1400 - 1459	A	1400 - 1459
B	1425 - 1449	B	1465 - 1479	B	up to 1399	B	up to 1399
C	1375 - 1424	C	1435 - 1464				
D	up to 1374	D	up to 1434				

17 – Bianchi

Event Numbers

1701: GRSB
1702: GRCF
1721: LBP
1722: LBR

Targets

GRSB: D1 reduced, 4 inch plates
GRCF, LBP, LBR: D1 full-size, 8 inch plates

Sights

Any

Positions

Standing unsupported, standing supported, kneeling and sitting
LBP & LBR may be shot prone in the Practical and Falling Plate matches (where range regulations allow); the butt of the revolver or pistol may touch the ground

Ready Position

GRSB, GRCF: parallel
LBP, LBR: holstered with both hands at the same height as the head or, for the Barricade Match, with both palms flat against the barricade

Course of Fire

This event takes approximately 90 minutes to complete.
It requires 192 rounds.
The maximum possible score is 1920.
Different conditions apply to each of the four types of firearm; these are shown under each match and referenced to each type.
The standard event for all championship meetings, which qualifies for classifications and record scores, consists of the Practical Match, the Falling Plate Match, the Barricade Match and the Moving Target Match. These can be shot in any order.
When one of the standard matches cannot be shot due to range limitations, the alternative matches (Los Alamitos and Rapid Fire) may be shot instead. In this case the event does not count towards classifications (even if it is shot in classes) or record scores.

Practical Match

This match is fired standing unsupported.

<i>Stage 1</i>	10 metres	3 seconds	1 shot on each target
		4 seconds	2 shots on each target
		8 seconds	3 shots on each target
<i>Stage 2</i>	15 metres	4 seconds	1 shot on each target
		5 seconds	2 shots on each target
			LBP, LBR: weak hand freestyle GRCF, GRSB: weak shoulder

<i>Stage 3</i> 25 metres	6 seconds	3 shots on each target
	5 seconds	1 shot on each target
<i>Stage 4</i> 50 metres	6 seconds	2 shots on each target
	7 seconds	3 shots on each target
	7 seconds	1 shot on each target
	10 seconds	2 shots on each target
	15 seconds	3 shots on each target

Falling Plate Match

This match is fired standing unsupported.

<i>Stage 1</i> 10 metres	6 seconds	1 shot on each plate
	6 seconds	1 shot on each plate
<i>Stage 2</i> 15 metres	7 seconds	1 shot on each plate
	7 seconds	1 shot on each plate
<i>Stage 3</i> 20 metres	8 seconds	1 shot on each plate
	8 seconds	1 shot on each plate
<i>Stage 4</i> 25 metres	9 seconds	1 shot on each plate
	9 seconds	1 shot on each plate

Barricade Match

This match is fired standing, supported by the barricade – the gun may touch the barricade.

<i>Stage 1</i> 10 metres	6 seconds	6 shots on a target from one side
	6 seconds	6 shots on the other target from the other side
<i>Stage 2</i> 15 metres	7 seconds	6 shots on a target from one side
	7 seconds	6 shots on the other target from the other side
<i>Stage 3</i> 25 metres	8 seconds	6 shots on a target from one side
	8 seconds	6 shots on the other target from the other side
<i>Stage 4</i> 35 metres	9 seconds	6 shots on a target from one side
	9 seconds	6 shots on the other target from the other side

Moving Target Match

This match is fired standing unsupported.

<i>Stage 1</i> 10 metres	6 seconds	6 shots, target moving right to left
	6 seconds	6 shots, target moving left to right
<i>Stage 2</i> 15 metres	6 seconds	6 shots, target moving right to left
	6 seconds	6 shots, target moving left to right
<i>Stage 3</i> 20 metres	6 seconds	3 shots, target moving right to left
	6 seconds	3 shots, target moving left to right
	6 seconds	3 shots, target moving right to left
	6 seconds	3 shots, target moving left to right
	6 seconds	3 shots, target moving right to left
	6 seconds	3 shots, target moving left to right
<i>Stage 4</i> 25 metres	6 seconds	3 shots, target moving right to left
	6 seconds	3 shots, target moving left to right
	6 seconds	3 shots, target moving right to left
	6 seconds	3 shots, target moving left to right
	6 seconds	3 shots, target moving right to left
	6 seconds	3 shots, target moving left to right

Alternative for Moving Target Match – Los Alamitos Match (modified)

Stages 1-5 of this match are shot standing unsupported. Stage 6 is shot standing supported by the barricade.

<i>Stage 1</i>	7 metres	3 seconds	2 shots on centre target
		3 seconds	2 shots on right target
		3 seconds	2 shots on left target
<i>Stage 2</i>	7 metres	5 seconds	2 shots on each target
<i>Stage 3</i>	7 metres	6 seconds	2 shots on each target, strong hand/shoulder
<i>Stage 4</i>	7 metres	10 seconds	2 shots on each target, weak hand/shoulder
<i>Stage 5</i>	10 metres	18 seconds	2 shots on each target Reload
			2 shots on each target, weak hand/shoulder
<i>Stage 6</i>	25 metres	10 seconds	2 shots on each target, right side of barricade
		10 seconds	2 shots on each target, left side of barricade

Alternative for Falling Plate Match – Rapid Fire Match (modified)

This match is shot standing unsupported.

<i>Stage 1</i>	25 metres	10 seconds	1 shot on each of targets 1, 3 & 5
		10 seconds	1 shot on each target
		10 seconds	1 shot on each target
<i>Stage 2</i>	25 metres	8 seconds	1 shot on each target
		8 seconds	1 shot on each target
<i>Stage 3</i>	25 metres	5 seconds	1 shot on each target
		5 seconds	1 shot on each target

Range Commands

The general rules apply with the addition of the following initial command.

Having made sure that the range is clear, the CRO commands 'LOAD AND MAKE READY'.

Ties

Tie breaking rules shall be applied in the order listed below:

- a. By the greatest number of Xs in the event
- b. By the highest score in the Moving Target Match
- c. By the highest score in the Falling Plate Match
- d. By the highest score in the Barricade Match
- e. By the highest score in the Practical Match

Target positions

Practical Match: Two targets, 4½ feet from centre to centre and about 6 feet to the top of the targets.

Falling Plate Match: Six 8 inch (GRCF, LBP, LBR) or six 4 inch (GRSB) plates placed at 20 inch centres and about 4 feet from the ground to the bottom edge.

Barricade Match: Two targets, 7½ feet from centre to centre and about 6 feet to the top of the targets.

Moving Target Match: One target, about 6 feet to the top of the target.

Los Alamitos Match: Three targets, 2½ feet from centre to centre and about 6 feet to the top of the targets.

Rapid Fire Match: Five targets, 3 feet from centre to centre and about 6 feet to the top of the targets.

Event specific range equipment

Barricade: 6 feet high, 2 feet wide, with a 2 foot wide by 3 foot long firing area behind the barricade for the shooter.

Moving Target: The target will move from concealment behind a cover, travel 60 feet in 6 seconds and disappear behind another cover.

Firing area: For the Moving Target Match there will be a clearly marked 3 foot square firing area at each distance at the centre of the 60 foot run of the target.

Procedural penalties – event specific

In addition to the usual procedural penalties, the following apply in this event:

- a. Lowering the hands from the start position before the start signal.
- b. Removing the hands from the barricade before the start signal.
- c. Firing a shot while a part of the foot is touching the ground outside the designated firing area.
- d. Firing a shot in the Moving Target Match which penetrates the cover on either side.

Classifications

The classification score bands are as follows:

GRSB		GRCF		LBP		LBR	
X	1870 - 1920	X	1890 - 1920	X	1825 - 1920	X	1825 - 1920
A	1820 - 1869	A	1850 - 1889	A	1750 - 1824	A	1750 - 1824
B	1750 - 1819	B	1815 - 1849	B	up to 1749	B	up to 1749
C	1600 - 1749	C	1725 - 1814				
D	up to 1599	D	up to 1724				

19 – Advancing Target

Event Numbers

1901: GRSB

1902: GRCF

1921: LBP

1922: LBR

Targets

GRSB: 1 x DP1a

GRCF, LBP, LBR: 1 x DP1

Sights

Any

Positions

Standing unsupported

Ready Position

45 degrees

Course of Fire

This event takes approximately 30 minutes to complete

It consists of 6 identical Practices

It requires 60 rounds (GRSB) or 36 rounds (GRCF, LBP, LBR)

The maximum possible score is 300 (GRSB) or 180 (GRCF, LBP, LBR)

Practice 1 – 6

Target will advance from 25 to 10 metres in about 10 seconds, then turn away

GRSB: 10 rounds to be fired while the target is facing

GRCF, LBP, LBR: 6 rounds to be fired while the target is facing

Range Commands

The general rules apply with the addition of the following initial command.

Having made sure that the range is clear, the CRO commands 'LOAD AND MAKE READY'.

Event specific range equipment

A target carrier capable of advancing from 25 metres to the firing line at an even pace. The target will start faced and will advance from 25 metres to 10 metres in 10 seconds. The target will edge at the 10 metre point.

Scoring

Where any competitor achieves the highest possible score, his targets must be removed from the backing boards, labelled and passed to Stats.

Ties

Tie breaking rules shall be applied in the order listed below:

- a. By the scores for each practice, commencing with the final practice and working backwards.

- b. In the event of the highest possible score being attained, by outward gauging.

Classifications

The classification score bands are as follows:

GRSB		GRCF		LBP		LBR	
X	285 - 300	X	178 - 180	X	175 - 180	X	175 - 180
A	260 - 284	A	170 - 177	A	165 - 174	A	165 - 174
B	up to 259	B	up to 169	B	up to 164	B	up to 164

21 – Speed Steel Challenge

Event Numbers

2101: GRSB
2102: GRCF (note that revolver-based GRCF are not permitted)
2121: LBP
2122: LBR

Targets

Four 18 inch diameter steel plates and one 18 x 24 inch steel plate per stage

Distances

22 to 30 metres

Sights

Any

Positions

Standing unsupported

Ready Position

GRSB, GRCF: Parallel
LBP, LBR: 45 degrees

Course of Fire

This event takes approximately 45 minutes to complete.
It consists of 5 stages and requires a minimum of 125 rounds to complete.
For GRCF and LBR, only lead bullets are allowed (no jacketed, armour-piercing or copper-washed).
For GRSB and LBP, both lead and copper-washed bullets are allowed.

Stages 1 – 5

5 runs on each stage with the fastest 4 runs from each stage to count, maximum of 30 seconds recordable for any one run.

On the audible start, the competitor will engage the 4 round steels with a minimum of 1 round on each in any order and then the rectangular stop-plate, which must be engaged last.

Range Commands

The general rules apply. However, each stage of this event operates independently with one shooter and one RO. Having made sure that the range is clear, the CRO gives the ROs permission to proceed and each RO will then issue the command 'LOAD AND MAKE READY' to the shooter on their stage.

Procedural penalties – event specific

If the rectangular stop-plate is hit before all 4 of the round steels have been hit, the time for that run is recorded as 30 seconds.

Ties

Tie breaking rules shall be applied in the order listed below:

- a. Fastest run on any stage.

23 – 25m Timed

Event Numbers

2301: LSR

Target

PL14

Sights

Any (spotting scopes may be used)

Position

Standing unsupported

Ready Position

45 degrees

Course of Fire

This event is shot at 25 metres
It takes approximately 45 minutes to complete
It requires 35 rounds
The maximum possible score is 300

Sighters

5 shots in 150 seconds

Practice 1

2 x 5 shots in 150 seconds

Practice 2

2 x 5 shots in 20 seconds

Practice 3

2 x 5 shots in 10 seconds

Range Commands

The general rules apply with the addition of the following initial command.
Having made sure that the range is clear, the CRO commands 'WITH FIVE ROUNDS LOAD AND MAKE READY'.

Scoring

Targets are scored at the end of each practice (i.e. there will be 10 shots on each target).

Malfunction Allowances

If a competitor suffers a gun malfunction which cannot be rectified during the time available to shoot the string of 5 shots and which results in fewer than 5 shots being fired, he may claim a Malfunction. In this case, he must leave the gun in the malfunction condition so that

it can be verified by the RO. If the RO confirms that the malfunction is the fault of the gun or ammunition, not the competitor, then the competitor will be allowed to reshoot the timed series of 5 shots on the same target. At the end of the practice, the lowest-scoring 10 shots will count.

Typical causes of an allowable malfunction include misfires and failed extraction of spent cases.

No competitor may be awarded more than two malfunction series during any one event.

Ties

Tie breaking rules shall be applied in the order listed below:

- a. By the greatest number of Xs in the event.
- b. By the scores in each practice in the order 3, 2, 1.
- c. By the X count in each practice in the order 3, 2, 1.

25 – Sport Pistol

Event Numbers

2521: LBP (multi-shot)

Targets

PL7 (Precision), PL17 (Rapid)

Sights

Any colour iron (spotting scopes may be used)

Position

Standing unsupported

Ready Position

45 degrees

Course of Fire

This event is shot at 25 metres
It takes approximately 2 hours to complete
It requires 70 rounds
The maximum possible score is 600

Sighters (Precision)

Sighters: 1 series of 5 shots in 6 minutes

Practice 1 – 3 (Precision)

2 x 5 shots in 6 minutes

Sighters (Rapid)

Sighters: 1 series of 5 shots, one shot to be fired at each appearance

Practice 4 – 6 (Rapid)

2 series of 5 shots
During each series, the target appears 5 times, each time for 3 seconds with an away time of 7 seconds between each appearance; 1 shot only to be fired at each exposure

Range Commands

The general rules apply with the addition of the following initial command.
Having made sure that the range is clear, the CRO commands 'WITH FIVE ROUNDS LOAD AND MAKE READY'.

Scoring

Targets are scored at the end of each practice (i.e. there will be 10 shots on each target).

Malfunction Allowances

If a competitor suffers a gun malfunction which cannot be rectified during the time available to shoot the string of 5 shots and which results in fewer than 5 shots being fired, he may claim a Malfunction. In this case, he must leave the gun in the malfunction condition so that it can be verified by the RO. If the RO confirms that the malfunction is the fault of the gun or ammunition, not the competitor, then the competitor will be allowed to reshoot the timed series of 5 shots on the same target. At the end of the practice, the lowest-scoring 10 shots will count.

Typical causes of an allowable malfunction include misfires and failed extraction of spent cases.

No competitor may be awarded more than four malfunction series during any one event – two in the Precision practices and two in the Rapid.

Ties

Tie breaking rules shall be applied in the order listed below:

- a. By the greatest number of Xs in the event.
- b. By the scores in each practice in the order 6, 5, 4, 3, 2, 1.
- c. By the X count in each practice in the order 6, 5, 4, 3, 2, 1.

27 – Standard Pistol

Event Numbers

2721: LBP (multi-shot)

Target

PL7

Sights

Any colour iron (spotting scopes may be used)

Position

Standing unsupported

Ready Position

45 degrees

Course of Fire

This event is shot at 25 metres in 6 practices
It takes approximately 90 minutes to complete
It requires 65 rounds
The maximum possible score is 600

Sighters

5 shots in 150 seconds

Practice 1 – 2

2 x series of 5 shots in 150 seconds

Practice 3 – 4

2 x series of 5 shots in 20 seconds

Practice 5 – 6

2 x series of 5 shots in 10 seconds

Range Commands

The general rules apply with the addition of the following initial command.
Having made sure that the range is clear, the CRO commands 'WITH FIVE ROUNDS LOAD AND MAKE READY'.

Scoring

Targets are scored at the end of each practice (i.e. there will be 10 shots on each target).

Malfunction Allowances

If a competitor suffers a gun malfunction which cannot be rectified during the time available to shoot the string of 5 shots and which results in fewer than 5 shots being fired, he may claim a Malfunction. In this case, he must leave the gun in the malfunction condition so that it can be verified by the RO. If the RO confirms that the malfunction is the fault of the gun or

ammunition, not the competitor, then the competitor will be allowed to reshoot the timed series of 5 shots on the same target. At the end of the practice, the lowest-scoring 10 shots will count.

Typical causes of an allowable malfunction include misfires and failed extraction of spent cases.

No competitor may be awarded more than four malfunction series during any one event.

Ties

Tie breaking rules shall be applied in the order listed below:

- a. By the greatest number of Xs in the event.
- b. By the scores in each practice in the order 6, 5, 4, 3, 2, 1.
- c. By the X count in each practice in the order 6, 5, 4, 3, 2, 1.

29 – The Grand

Event Numbers

2901: GRSB

Targets

2 x DP2, 2 x 'Melon', 2 x '5 of Diamonds'

Sights

Any

Positions

Standing unsupported, sitting, kneeling

Ready Position

45 degrees

Course of Fire

This event takes approximately 1 hour to complete
It requires 100 rounds to complete
The maximum possible score is 1000

Practice 1

Stage 1 25 metres, standing unsupported
10 shots on a DP2 target
3 exposures of 4 seconds
Any number of shots may be fired at each exposure
Stage 2 25 metres, kneeling
10 shots on a DP2 target
3 exposures of 4 seconds
Any number of shots may be fired at each exposure

Practice 2

25 metres, sitting
10 shots on a 'melon' target
1 exposure of 8 seconds

Practice 3

Stage 1 25 metres, standing unsupported
10 shots on a 'five of diamonds' target
1 exposure of 12 seconds, 2 shots on each diagram
Stage 2 25 metres, kneeling
10 shots on a 'five of diamonds' target
1 exposure of 12 seconds, 2 shots on each diagram

Practice 4

Stage 1 50 metres, standing unsupported
10 shots on a DP2 target
3 exposures of 6 seconds
Any number of shots may be fired at each exposure

Stage 2 50 metres, kneeling
10 shots on a DP2 target
3 exposures of 6 seconds
Any number of shots may be fired at each exposure

Practice 5

50 metres, sitting
10 shots on a 'melon' target
1 exposure of 9 seconds

Practice 6

Stage 1 50 metres, standing unsupported
10 shots on a 'five of diamonds' target
1 exposure of 15 seconds, 2 shots on each diagram
Stage 2 50 metres, kneeling
10 shots on a 'five of diamonds' target
1 exposure of 15 seconds, 2 shots on each diagram

Range Commands

The general rules apply with the addition of the following initial command.
Having made sure that the range is clear, the CRO commands 'WITH TEN ROUNDS LOAD AND MAKE READY'.

Scoring

In addition to the general rules, each miss in Practices 3 and 6 incurs a 10 point penalty.

Ties

Tie breaking rules shall be applied in the order listed below:

- a. By the greatest number of Xs in the event.
- b. By the scores in each practice in the order 6, 5, 4, 3, 2, 1.
- c. By the X count in each practice in the order 6, 5, 4, 3, 2, 1.

38 – Man v Man

Event Numbers

3801: GRSB

Targets

Five targets and one stop target, c.15 cm across, which clearly show when hit

Sights

Any

Positions

Standing unsupported

Ready Position

The rifle on a table at the firing line, loaded with the slide forward but not made ready.

Standing behind the table with a can in the strong hand.

Course of Fire

This event is shot on a knockout basis – competitors shoot each round in pairs.

It takes approximately 60 minutes to complete.

It is shot at 10 metres.

At the start signal, the competitor places the can on a post at the table. If the can is dropped on the table, it may be retrieved. If it drops anywhere else, it may not be retrieved and the run is lost.

Pick up the rifle, make ready and engage the first five targets until all are hit.

After a compulsory reload, engage the stop plate until it is hit.

The first competitor to hit the stop plate wins the run.

The best of three runs wins the round.

There is no allowance for malfunctions.

Range Commands

The general rules apply with the addition of the following initial command. Having made sure that the range is clear, the CRO commands 'LOAD BUT DO NOT MAKE READY'.

Loading

All ammunition must be carried on the competitor's person or placed on the table provided. Any type of magazine may be used but they can only be loaded with a maximum of ten rounds. Any dropped magazines can only be retrieved from the table. A reload requires a magazine to be removed entirely from the rifle and a fresh magazine fully inserted and locked. Magazines that are clipped together, e.g. back to back or side by side, may not be reinserted – a fresh magazine must be taken from the competitor's person or the table.

Event specific range equipment

A can and a table and post for each competitor at the firing point.

A chair behind the firing line for each competitor waiting for the next round.

Procedural penalties – event specific

There is no numerical score in this event, so Procedural Penalties are not handled in the usual way. Instead, a competitor automatically loses any run in which he receives a Procedural penalty. In addition to the standard reasons for such a penalty, the following apply in this event:

- a. Failing to place the can on the post before picking up the rifle.
- b. Engaging the stop target before hitting all of the other targets or before reloading.
- c. Retrieving a dropped magazine or can from anywhere other than the table.
- d. Engaging any target belonging to the other competitor.

39 – Metallic Silhouettes

Event Numbers

3901: GRSB

Targets

2 sets of 5 miniature animal shaped steel targets at each of the following distances:

40 yards	Chickens
60 yards	Pigs
77 yards	Turkeys
100 yards	Rams

Sights

Any

Positions

Standing unsupported

Ready Position

Rifle held in both hands pointing at target array

Course of Fire

The event takes approximately 60 minutes to complete

It requires 40 rounds (plus sighters if allowed at the meeting)

The maximum possible score is 40

The 5 targets in each set must be engaged from left to right in order, within 2½ minutes, 1 shot allowed at each target

Targets must fall to score

Targets which fall out of the correct order do not score

This is repeated to make a total of 10 shots at each distance and repeated for each distance

Reloading between each 5 shot series must be completed within 30 seconds

Range Commands

The general rules apply with the addition of the following initial command.

Having made sure that the range is clear, the CRO commands 'WITH FIVE ROUNDS LOAD AND MAKE READY'.

Equipment

A competitor may wear any shooting vest which complies with IMSSU rules.

43 – Granet

Event Numbers

4301: GRSB
4302: GRCF

Targets

PL17

Sights

Any (spotting scopes may be used)

Position

Standing unsupported

Ready Position

45 degrees

Course of Fire

This event is shot at 25 metres
It takes approximately 45 minutes to complete
It requires 35 rounds
The maximum possible score is 300

Sighters

1 series of 5 shots – the target appears 5 times, each time for 3 seconds with an away time of 7 seconds between each appearance; 1 shot only to be fired at each appearance

Practice 1 – 3

2 series of 5 shots per practice
During each series, the target appears 5 times, each time for 3 seconds with an away time of 7 seconds between each appearance; 1 shot only to be fired at each appearance

Range Commands

The general rules apply with the addition of the following initial command.
Having made sure that the range is clear, the CRO commands 'WITH FIVE ROUNDS LOAD AND MAKE READY'.

Scoring

Targets are scored at the end of each practice (i.e. there will be 10 shots on each target).

Malfunction Allowances

If a competitor suffers a gun malfunction which cannot be rectified during the time available to shoot the string of 5 shots and which results in fewer than 5 shots being fired, he may claim a Malfunction. In this case, he must leave the gun in the malfunction condition so that it can be verified by the RO. If the RO confirms that the malfunction is the fault of the gun or

ammunition, not the competitor, then the competitor will be allowed to reshoot the timed series of 5 shots on the same target. At the end of the practice, the lowest-scoring 10 shots will count.

Typical causes of an allowable malfunction include misfires and failed extraction of spent cases.

No competitor may be awarded more than two malfunction series during any one event.

Ties

Tie breaking rules shall be applied in the order listed below:

- a. By the greatest number of Xs in the event.
- b. By the scores in each practice in the order 3, 2, 1.
- c. By the X count in each practice in the order 3, 2, 1.

45 – Scott

Event Numbers

4501: GRSB

Targets

PL7

Sights

Any (spotting scopes may be used)

Position

Standing unsupported

Ready Position

45 degrees

Course of Fire

This event is shot at 25 metres
It takes approximately 1 hour to complete
It requires 35 rounds
The maximum possible score is 300

Sighters

Sighters: 1 series of 5 shots in 5 minutes

Practice 1 – 3

2 series of 5 shots in 5 minutes per practice

Range Commands

The general rules apply with the addition of the following initial command.
Having made sure that the range is clear, the CRO commands 'WITH FIVE ROUNDS LOAD AND MAKE READY'.

Scoring

Targets are scored at the end of each practice (i.e. there will be 10 shots on each target).

Malfunction Allowances

If a competitor suffers a gun malfunction which cannot be rectified during the time available to shoot the string of 5 shots and which results in fewer than 5 shots being fired, he may claim a Malfunction. In this case, he must leave the gun in the malfunction condition so that it can be verified by the RO. If the RO confirms that the malfunction is the fault of the gun or ammunition, not the competitor, then the competitor will be allowed to reshoot the timed series of 5 shots on the same target. At the end of the practice, the lowest-scoring 10 shots will count.

Typical causes of an allowable malfunction include misfires and failed extraction of spent cases.

No competitor may be awarded more than two malfunction series during any one event.

Ties

Tie breaking rules shall be applied in the order listed below:

- a. By the greatest number of Xs in the event.
- b. By the scores in each practice in the order 3, 2, 1.
- c. By the X count in each practice in the order 3, 2, 1.

47 – Imperial Silhouettes

Event Numbers

4701: GRSB
4702: GRCF

Target

PL17

Sights

Any (spotting scopes may be used)

Position

Standing unsupported

Ready Position

45 degrees

Course of Fire

This event is shot at 25 metres
It takes approximately 45 minutes to complete
It requires 35 rounds
The maximum possible score is 300

Sighters

1 series of 5 shots in 12 seconds (GRCF) or 10 seconds (GRSB)

Practice 1

2 series of 5 shots in 12 seconds (GRCF) or 10 seconds (GRSB)

Practice 2

2 series of 5 shots in 10 seconds (GRCF) or 8 seconds (GRSB)

Practice 3

2 series of 5 shots in 8 seconds (GRCF) or 6 seconds (GRSB)

Range Commands

The general rules apply with the addition of the following initial command.
Having made sure that the range is clear, the CRO commands 'WITH FIVE ROUNDS LOAD AND MAKE READY'.

Scoring

Targets are scored at the end of each practice (i.e. there will be 10 shots on each target).

Malfunction Allowances

If a competitor suffers a gun malfunction which cannot be rectified during the time available to shoot the string of 5 shots and which results in fewer than 5 shots being fired, he may claim a Malfunction. In this case, he must leave the gun in the malfunction condition so that

it can be verified by the RO. If the RO confirms that the malfunction is the fault of the gun or ammunition, not the competitor, then the competitor will be allowed to reshoot the timed series of 5 shots on the same target. At the end of the practice, the lowest-scoring 10 shots will count.

Typical causes of an allowable malfunction include misfires and failed extraction of spent cases.

No competitor may be awarded more than two malfunction series during any one event.

Ties

Tie breaking rules shall be applied in the order listed below:

- a. By the greatest number of Xs in the event.
- b. By the scores in each practice in the order 3, 2, 1.
- c. By the X count in each practice in the order 3, 2, 1.